

We put science to work.™



**Savannah River
National Laboratory™**

OPERATED BY SAVANNAH RIVER NUCLEAR SOLUTIONS

A U.S. DEPARTMENT OF ENERGY NATIONAL LABORATORY • SAVANNAH RIVER SITE • AIKEN, SC

Hanford Tank Farm Vapors Abatement Technology and Vendor Proposals Assessment

H.H. Burns

M.E. Farrar

S.D. Fink

September 2016

SRNL-STI-2016-00484, Revision 0

SRNL.DOE.GOV

DISCLAIMER

This work was prepared under an agreement with and funded by the U.S. Government. Neither the U.S. Government or its employees, nor any of its contractors, subcontractors or their employees, makes any express or implied:

1. warranty or assumes any legal liability for the accuracy, completeness, or for the use or results of such use of any information, product, or process disclosed; or
2. representation that such use or results of such use would not infringe privately owned rights; or
3. endorsement or recommendation of any specifically identified commercial product, process, or service.

Any views and opinions of authors expressed in this work do not necessarily state or reflect those of the United States Government, or its contractors, or subcontractors.

Printed in the United States of America

**Prepared for
U.S. Department of Energy**

Keywords: *Example keywords*

Retention: *Permanent*

Hanford Tank Farm Vapors Abatement Technology and Vendor Proposals Assessment

H.H. Burns
M.E. Farrar
S.D. Fink

September 2016

Prepared for the U.S. Department of Energy under
contract number DE-AC09-08SR22470.



REVIEWS AND APPROVALS

AUTHORS:

Hedder H. Burns 9/20/16
H.H. Burns, SRNL Hanford Mission Programs Date

M.E. Farrar 9/20/16
M.E. Farrar, SRNL, Research and Development Engineering Date

Samuel D. Fink 20 September 2016
S.D. Fink, SRNL Hanford Mission Programs Date

TECHNICAL REVIEW:

D.T. Hobbs 9/20/2016
D.T. Hobbs, SRNL, Reviewed per E7 2.60 Date

APPROVAL:

Connie C. Herman 9/23/16
C.C. Herman, Director, SRNL Hanford Mission Programs Date

G.E. Weeks 9/28/16
G.E. Weeks, WRPS Technical Lead, WRPS Chief Technology Office Date

EXECUTIVE SUMMARY

Suspected chemical vapor releases from the Hanford nuclear waste tank system pose concerns for worker exposure. Washington River Protection Solutions (WRPS) contracted the Savannah River National Laboratory (SRNL) to explore abatement technologies and strategies to remediate the vapors emitted through the ventilation system. In response, SRNL conducted an evaluation of technologies to abate, or reduce, vapor emissions to below 10% of the recognized occupational exposure limits (OELs). The evaluation included a review of published literature and a broadly communicated Request for Information to commercial vendors through a Federal Business Opportunities (Fed Biz Opps) web posting. In addition, SRNL conducted a workshop and post-workshop conference calls with interested suppliers (vendors) to assess proposals of relevant technologies.

This report reviews applicable technologies and summarizes the approaches proposed by the vendors who participated in the workshop and teleconference interviews. In addition, the report evaluates the estimated performance of the individual technologies for the various classes of chemical compounds present in the Hanford Chemicals of Potential Concern (COPCs) list. Similarly, the report provides a relative evaluation of the vendor proposed approaches against criteria of: technical feasibility (and maturity), design features, operational considerations, secondary waste generation, safety/regulatory, and cost / schedule. These rough order of magnitude (ROM) cost estimates are intended to provide a comparison basis between technologies and are not intended to be actual project estimates.

This assessment indicates that abatement of the COPCs requires more than a single technology **if** the final selected performance metric is to reduce the concentrations in the ventilation system exhaust to below 10% of the OELs.

Moderate ventilation upgrades for passive vented tanks is likely an essential step for any technology deployment to address fugitive vapor risk. Most of the tanks use passive ventilation and as such provide only a minimal driving force to remove volatile organic species that form from ongoing radiolysis. Converting these tanks to an active ventilation system provides a means to remove volatile organic compounds continuously, reduce accumulation of vapors in the waste tank, and control potential fugitive leak paths for these vapors.

Based on assessment of the collective information, SRNL provides the following recommendations for continued research to enable down-selection of a technology(s) for abatement of Hanford Tank Farm COPCs. The selected technologies can then be pilot-tested in the field prior to future deployment.

- Develop a firmer technical basis for the performance metric. The suggested target of < 10% of the OELs is a credible initial concept. However, the program should further assess the health hazard posed by each COPC and the ability to monitor its presence at those concentrations.
- Conduct a review of measured vapor compositions to define a subset of species (a) that are tractable with existing mature monitoring technologies, (b) that spans the range of chemical behavior for the bulk of the vapor stream, and (c) that represents an engineering practical subset for assessing pilot scale demonstrations of the most promising abatement options.
- Strobic Air designs and deploys high velocity fans for dispersion of off-gas streams from process operations and laboratories. These fans avoid the need for excessively tall stacks due to the velocities involved. Conduct air dispersion modeling to both optimize the fan system design and provide a basis for comparison of these high performance fans to conventional fans in current use in the active

ventilation systems. Perform a study to develop conceptual designs for deployment of these fans, if warranted, based upon the results of the modeling.

- NUCON International proposed using a conventional internal combustion engine with a catalytic converter as the core of the treatment. This concept is the simplest approach suggested for an oxidizer. NUCON is internally funding a pilot test. SRNL should provide technical consultation to NUCON to ensure the test program meets the program needs and assess test results for WRPS.
- In FY17, further investigate – including use of laboratory testing – the combined use of moderate temperature, catalytic oxidation followed by dry bed sorption as a treatment option. In this phase, SRNL will examine synergistic use of sorbent polymer catalyst filters (from W .L. Gore and Associates) and dry bed sorbents (from Calgon Carbon) to treat the off-gas.
- Assess and select a media for treatment of mercury emissions. The selection should examine relative performance of commercial dry bed adsorbents and the promising filter membrane material deployed extensively by W.L. Gore & Associates.
- Prepare for full-size demonstrations of the two leading technologies. Siting of the demonstration should consider a (currently) passively ventilated tank with suspected higher organic content to provide a more challenging demonstration. In addition, use of a passively ventilated tank may avoid conflicts with other planned evolutions, limiting the operations to only those associated with the demonstrations.

TABLE OF CONTENTS

LIST OF TABLES	viii
LIST OF FIGURES	ix
LIST OF ABBREVIATIONS	x
1.0 Introduction	1
2.0 Technology Assessments	2
2.1 Dispersion/Ventilation	3
2.2 Adsorption	4
2.3 Filtration or Membranes	8
2.4 Thermal Oxidation	10
2.5 Absorption	12
2.6 Non-Thermal Destruction	15
2.7 Condensation	16
2.8 Aerosol/Particulate Control	18
2.9 Biodegradation / Biofiltration	19
3.0 Vendor Proposals	20
3.1 Calgon Carbon	20
3.2 HEE/Duall	25
3.3 NESTEC	28
3.4 W. L. Gore & Associates	31
3.5 Schenck Process Group	35
3.6 ALZETA/Anguil	38
3.7 John Zink Hamworthy Combustion	42
3.8 Beltran	44
3.9 NUCON, International	45
3.10 Project Integration	50
3.11 Comi Polaris	53
3.12 HGI Industries	56
3.13 Advanced Air Technologies	58
3.14 Bionomic Industries	61
3.15 B&W MEGTEC	64
3.16 Strobic Air	68
4.0 Results and Discussion	70
5.0 Recommendations, Path Forward and Future Work	72
6.0 References	75

LIST OF TABLES

Table 2-1 Vendors that Included Adsorption in Proposed Vapor Abatement Solution.....	5
Table 2-2 Design Considerations for Carbon Adsorption System.....	6
Table 2-3 Vendors that Included Adsorption in Proposed Vapor Abatement Solution.....	13
Table 3-1. Calgon Carbon Technology Estimated Removal Efficiencies of Hanford COPC Groups.....	22
Table 3-2. Design Features of Calgon Carbon Adsorbent System	23
Table 3-4. Summary of Calgon Carbon’s Adsorption System Evaluation	24
Table 3-5. HEE/Duall Projected Removal Efficiencies of Hanford Tank Farms Targeted COPC Groups26	
Table 3-6. Design Features of HEE/Duall Wet Scrubber and Carbon Bed Technologies.....	26
Table 3-7. Operational Considerations of HEE/Duall Wet Scrubber and Carbon Bed Technologies.....	27
Table 3-8. Summary of HEE/Duall’s Wet Scrubber and Carbon Bed Technologies	28
Table 3-9. NESTEC Projected Destruction Removal Efficiencies of Hanford Tank Farms Targeted COPC Groups	29
Table 3-10. Design Features of the NESTEC Regenerative Thermal Oxidation System.....	29
Table 3-11. Operational Considerations for the NESTEC Regenerative Thermal Oxidation System.....	30
Table 3-12. Summary of NESTEC Regenerative Thermal Oxidation System Evaluation.....	31
Table 3-13. W.L. Gore’s Projected Removal Efficiencies of Hanford Tank Farms Targeted COPC Groups	32
Table 3-14 Design Features of W. L. Gore Mercury Control System.....	33
Table 3-15. Operational Considerations for the W. L. Gore Catalytic Filtration and Chemi-Adsorption Technologies.....	34
Table 3-16. Summary of W.L. Gore Technologies Evaluation	35
Table 3-17. Destruction probability for Hanford Off-gas Constituents by Non-Thermal Plasma.....	36
Table 3-18. Summary of Schenck Process’s Non-Thermal Plasma System Evaluation.....	37
Table 3-19. ALZETA/Anguill Projected Destruction Removal Efficiencies of Hanford Tank Farms Targeted COPC Groups.....	39
Table 3-20. Design Features of the ALZETA/Anguill Flameless Thermal Oxidation System	39
Table 3-21. Operational Considerations for the ALZETA/Anguill Flameless Thermal Oxidation System40	
Table 3-22. Summary of ALZETA/Anguill Thermal Oxidation System Evaluation	41
Table 3-23. John Zink’s Thermal Oxidation System Projected Destruction Removal Efficiencies of Hanford Tank Farms Targeted COPC Groups	42
Table 3-24. Design Features of the John Zink Thermal Oxidation System.....	42
Table 3-25. Operational Considerations for the John Zink Thermal Oxidation System.....	43
Table 3-26. Summary of the John Zink Thermal Oxidation System Evaluation.....	44
Table 3-27. Summary of Beltran Technologies’ Wet Electrostatic Precipitator System Evaluation.....	45
Table 3-28. NUCON’s Projected Destruction Removal Efficiencies of Hanford Tank Farms Targeted COPC Groups	47
Table 3-29 MERSORB® Removal Efficiencies from Various Applications.....	47
Table 3-30. Design Features of the NUCON Carbon Sorption and Internal Combustion Engine System 48	
Table 3-31. Operational Considerations for the NUCON Carbon Sorption and Internal Combustion Engine System	48
Table 3-32. Summary of NUCON Thermal Oxidation and Carbon Bed System Evaluation.....	50
Table 3-33 Mercury Removal Efficiency for Combined Activated Carbon Injection and Baghouse	51
Table 3-34. Project Integration Thermal Oxidation/ Activated Carbon Injection System Removal Efficiencies of Hanford Tank Farms Targeted COPC Groups	51
Table 3-35. Design Features of Project Integration’s Thermal Oxidation/Carbon Injection System	51
Table 3-36. Operational Considerations for the Project Integration Thermal Oxidation/ Carbon Injection System	52
Table 3-37. Project Integration Thermal Oxidation/Carbon Injection System Evaluation Summary	53

Table 3-38. Design Features of Comi Polaris Proposal	54
Table 3-39. Consumables for Comi Polaris Cryogenic Unit to Treat ~3000 scfm Hanford Off-gas.....	55
Table 3-40. Secondary Waste for Comi Polaris Proposed Treatment	55
Table 3-41. Summary of Comi Polaris' Cryogenic Condensation System Evaluation	56
Table 3-42. Predicted Ability of Treatment Technology to Achieve Targeted Performance for Chemical Classes in Hanford COPCs.....	57
Table 3-43. Summary of HGI Industries' Hydroxyl Injection System Evaluation.....	58
Table 3-44. Advanced Air Technologies Projected Removal Efficiencies of Hanford Tank Farms Targeted COPC Groups.....	59
Table 3-45. Design Features of Advanced Air Technologies Scrubber/Carbon Bed Technologies.....	59
Table 3-46. Operational Considerations of Advanced Air Technologies Scrubber/Carbon Bed Technologies.....	60
Table 3-47. Summary of Advanced Air Technologies Absorption/Adsorption System Evaluation	61
Table 3-48. Bionomic Projected Destruction Removal Efficiencies of Hanford Tank Farms Targeted COPC Groups	62
Table 3-49. Design Features of the Bionomic Multi-Technology Abatement System.....	62
Table 3-50. Operational Considerations for the Bionomic Multi-Technology Abatement System.....	63
Table 3-51. Summary of Bionomic Multi-Technology System Evaluation	64
Table 3-52. B&W MEGTEC's Thermal Oxidation/Selective NO _x Reduction/Carbon Adsorption System Removal Efficiencies of Hanford Tank Farms Targeted COPC Groups.....	65
Table 3-53. Design Features of the B&W MEGTEC Thermal Oxidation/Selective NO _x Reduction/Carbon Adsorption System	65
Table 3-54. Operational Considerations for the B&W MEGTEC Thermal Oxidation/Selective NO _x Reduction/Carbon Adsorption System	66
Table 3-55. Summary of the B&W MEGTEC Thermal Oxidation/Selective NO _x Reduction/Carbon Adsorption System Evaluation	67
Table 3-56. Summary of Strobic Air Tri-Stack [®] Exhaust System Evaluation.....	70
Table 4-1 Projected Ability of Treatment Technology to Achieve Targeted Performance for Chemical Classes in Hanford COPCs.....	70
Table 4-2 Panel Evaluation of the Vendor Proposed Treatment Flowsheets.....	72

LIST OF FIGURES

Figure 3-1 Two-stage Calgon Carbon VENTSORB [®] System	20
Figure 3-2. HEE/Duall's Proposed Three Stage Wet Scrubbing System	25
Figure 3-3 GORE [®] DeNO _x Catalytic Filter Bags combine an outer layer filter bag for particulate removal with a catalyst insert for NO _x and NH ₃ reduction.....	32
Figure 3-4. The ALZETA Flameless Thermal Oxidizer EDGE QR [™] System.....	38
Figure 3-5. NUCON's Proposed Abatement Strategy with Oxidation and Adsorption Technologies.....	46
Figure 3-6. Project Integration's Proposed Thermal Oxidation/Carbon Injection System	50
Figure 3-7. Conceptual Process Flowchart for Comi Polaris proposed Treatment System	54
Figure 3-8. B&W Thermal Oxidizer.....	64
Figure 3-9. The Strobic Air Tri-Stack [®] Exhaust System	68

LIST OF ABBREVIATIONS

amp	ampere
Btu	British thermal unit
°C	degrees Celsius
CO ₂	carbon dioxide
DRE	destruction and removal efficiency
DOE	Department of Energy
ESP	electrostatic precipitator
ePTFE	expanded polytetrafluoroethylene
°F	degrees Fahrenheit
fpm	feet per minute
FTO	Flameless Thermal Oxidizer
ft/s	feet per second
GAC	granular activated carbon
gpm	gallons per minute
h	hour
HCl	hydrogen chloride
HEPA	high efficiency particulate air
hp	horsepower
Hz	hertz
in w.g.	inches water gauge (1 in w.g. = 0.038 psig)
kW	kilowatt
lb	pounds
LEL	Lower Explosive Limit
ng TEQ/Nm ³	nanograms of dioxin toxic equivalent per Nm ³ (note: 1 scfm = 1.61 Nm ³ /h)
NaBr	sodium bromide
NaOH	sodium hydroxide
NH ₃	ammonia
OEL	Occupational Exposure Limit
NO _x	generic term for nitric oxide and nitrogen dioxide
PLC	programmable logic controller
RTO	regenerative thermal oxidizer
scfh	standard cubic foot per hour
scfm	standard cubic foot per minute
SCR	selective catalytic reactor

SNCR	selective non-catalytic reactor
SRNL	Savannah River National Laboratory
TBD	to be determined
UV	ultraviolet
VOC	volatile organic compound
WRPS	Washington River Protection Solutions

1.0 Introduction

Chemical vapor releases from the Hanford nuclear waste tank system pose concerns for worker exposure. (Wilmarth, 31 October 2014) Washington River Protection Solutions (WRPS) contracted the Savannah River National Laboratory (SRNL) to explore abatement technologies and strategies to remediate the vapors emitted through the ventilation system. (WRPS, 3 February 2016) In response, SRNL developed a plan for the technology survey (Burns, June 2016) and received concurrence from the WRPS Technical Lead. Following the approved approach, SRNL conducted an evaluation of technologies to abate, or reduce, vapor emissions to below 10% of the recognized occupational exposure limits (OELs). (WRPS, 3 February 2016)

The evaluation included a review of published literature and a broadly communicated Request for Information to commercial vendors through a Federal Business Opportunities (Fed Biz Opps) web posting. (SRNL, 14 June 2016) Appendix A contains the Request as archived requests are difficult to locate on the website. Appendix B contains a list of all vendors contacted by the authors.

In addition, SRNL conducted a workshop (19-21 July, Richland, WA) and post-workshop conference calls with interested suppliers (vendors) to assess proposals of relevant technologies. (Appendix C contains background information sent to the vendors to help them frame a proposed treatment. In addition to these transmitted materials, vendors typically held extended e-mail or telephone dialogues with one or more of the authors to gain an understanding of the need and application.)

The vapors emitted from the waste tanks (Stock, July 2004) include approximately 2000 chemicals arranged broadly into 19 different groups. The initial scope of work (WRPS, 3 February 2016) indicates that a smaller group of 7 to 8 COPCs is common to multiple waste tanks. Additionally, two broad styles of waste tanks exist at Hanford with different styles of ventilation. The Single Shell Tanks use passive ventilation while the Double Shell Tanks employ active (forced air) ventilation. The large variation in flow rates and the wide range of chemical compounds will pose substantial challenges for any abatement technology.

In assessing the individual technologies, the team first considered whether the technology provided effective treatment of the various chemical groups that comprise the COPCs. The team used the following broad groups: volatile organic carbons (VOCs) with emphasis on amines, dioxins /furans, NO_x, ammonia, and mercury.

Ranking the relative merit of vendor proposed approaches required establishment of rating criteria. The evaluation team assessed the technical maturity and demonstrated industrial or nuclear application of the competing technologies, with preference assigned to commercially demonstrated technologies. Other factors for consideration included applicability to multiple COPCs, required utilities, secondary waste stream generation, degree of complexity for operation, robustness of operation in proposed environment, and cost and schedule. The costs were rough order of magnitude (ROM) estimates provided by the vendors and were used to provide a comparison basis between technologies and were not intended as actual project estimates.

SRNL developed the following list of criteria for use in rating the vendor proposed approaches.

- Technical Feasibility
 - The proposed approach is sufficiently mature to provide high confidence that destruction or removal efficiencies (DREs) for the COPCs will yield final vapor concentrations that compare favorably with 10% of the respective OELs. The vendor proposals were evaluated based upon how well their proposed technologies abate ALL of the COPC chemical groups (collectively).

- The technology is sufficiently mature to allow “near term” deployment at Hanford. “Near term” reflects approaches that are ready for final design or ready for pilot trials, within the Hanford Tank Farm, within the next 1-2 years.
- Design Features
 - The conceptual flowsheet is sufficiently defined to understand the unit operations, principal equipment and required utilities.
- Operational Considerations
 - Ability for treatment facility/process to be efficiently operated and maintained.
 - Degree of process/operating complexity.
- Secondary Waste Generation
 - Ability to treat and dispose of secondary liquid and solid waste streams (considering the volume and complexity of treatment).
- Safety / Regulatory
 - The technology minimizes hazards needing active engineering/administrative controls to maintain safety.
 - Credible disposal paths exist for any secondary waste.
 - The team believes safety and regulatory analysis will not prove onerous.
- Costs and Schedule
 - Full cost and schedule evaluation is beyond the scope of this assessment. However, the team assessed equipment cost estimates and deployment costs to the extent practical based on information provided by the vendor or other sources and relying on the experience of the team members for prior DOE projects. These ROM cost estimates were used to provide a basis for technology comparison purposes only.

SRNL consulted two primary resources in developing this list of criteria. First, the Department of Energy established a guide for determination of technology readiness (DOE Office of Environmental Management, 15 September 2011 Change 1) that provides criteria for such evaluations. Within this guide, the DOE provides distinct definition of technology maturation levels and the criteria for determination. Secondly, SRNL consulted a similar evaluation recently conducted at Hanford (by WRPS) to ascertain insight into the approach used for the specific site. The list of criteria merges elements of the two sources and adapts them for this specific evaluation.

For both rating processes, the team used a simple three-tiered (or “stoplight”) gradation rather than attempt to develop a defensible numerical scale. The ratings in this report reflect the decisions of the authors. Subject matter experts from Hanford contractors, the DOE Office of River Protection, and other support personnel attended and participated in the workshop and follow-on telephone interviews with vendors. (Appendix D contains a list of these “ex officio members” from the workshop.) These individuals provided their impressions and ratings to the authors as well. The authors benefitted significantly from this and factored these inputs into the final ratings.

2.0 Technology Assessments

The authors performed a limited review of published literature and available vendor materials for abatement technologies judged reasonably mature for possible deployment in the Hanford Tank Farms. Available literature is immense. A full coverage in this report is neither practical nor additive to the focused scope of interest. Therefore, the following sections cover the nine technologies that span the proposed approaches identified in the interactions with the vendors (U.S. EPA, March 2006). These technologies represent the most practical and widely used emissions abatement approaches used in industry.

2.1 Dispersion/Ventilation

Most of the tanks use passive ventilation and as such provide only a minimal driving force to remove volatile organic species that form from ongoing radiolysis. Providing these tanks with an active ventilation system provides a means to remove volatile organic compounds continuously and can reduce the buildup of vapors in the headspace and control potential fugitive leak paths for these vapors.

2.1.1 *Technical Feasibility*

Designs frequently use mixed impellor flow fans for laboratory and process exhaust in populated areas to manage odors when the odor threshold is significantly lower than exposure limits. (Gans, 2006) The high velocity of this fan design ejects the diluted contaminants into the air away from the breathing zone. Dilution factors of 100 or more in combination with effective stack heights of up to 90 feet maintain contaminant concentrations well below human detection thresholds. Deployment for the Hanford application will also need to verify sufficient dilution below hazardous exposure limits for workers and the public.

All of the VOC abatement technologies reviewed, with perhaps the exception of carbon adsorption and ultraviolet hydrolysis, assume active ventilation. In addition, mitigation of potential fugitive vapor emissions from the waste tanks requires use of active ventilation. Use of high velocity, high dilution factor fans provides assurance that contaminant concentrations from all sources remain below regulatory and human detection thresholds.

Only a single vendor, Strobic Air Corporation of CECO Environmental, included this technology as a significant feature within their proposals. Hence, the reader will find the detailed discussion of this technology in Section 3.4.

2.1.2 *Design Features*

While the footprint of mixed-flow impeller fans depends on the rated system flow, it will be smaller than the stack it would replace with a similar effective stack height.

Fans require three phase power for fan motors in the range of 3 hp to 80 hp.

The project will need to assess the use of this commercial grade equipment for use in the Hanford Tank Farm. The planning assumption for this study is that installation downstream of HEPAs may allow commercial grade dedication of the equipment under the Quality Assurance program.

2.1.3 *Operational Considerations*

Fans do not necessarily require monitoring although remote indication of operation is often desirable. As with all rotating equipment, fans require routine maintenance.

Limiting particulate concentration in the dilution air lengthens the design life of the impellers. Placement of high efficiency particulate air (HEPA) filters in advance of the fans achieves this objective.

2.1.4 *Secondary Waste*

The spent HEPA filters are the only known secondary waste.

2.1.5 *Safety/Regulatory*

For all the technologies, the project will need to assess permitting requirements for:

- addition of vapor abatement system to both passively and actively ventilated systems, and
- equipping passively ventilated tanks with a common ventilation system.

2.1.6 Cost/Schedule

Cost depends greatly on the final system design. However, these mixed impellor flow fans are relatively low cost alternatives to conventional centrifugal fans. If used in conjunction with other abatement technologies these fans can provide the required off-gas flow and enhance the overall reduction in concentrations for the emitted off-gas.

Robust designs exist for direct use in the Hanford application. Delivery times should prove relatively short (e.g., several months to no more than one year).

NOTE: The deployment of any technology assessed in this report requires the systems engineering design, safety analysis, and permitting activities integral to the DOE requirements. It is highly likely that the site “user” preparation scope will dominate the overall schedule relative to the commercial delivery time for the equipment for any technology considered in this report. The equipment costs and delivery times claimed by the vendors throughout the report reflect their respective experience and most typically reflect commercial, non-nuclear equipment (i.e., assuming use of commercial grade dedication). (Exceptions exist for select vendors such as NUCON International and John Zink Hamworthy Combustion who have experience delivering to DOE sites for nuclear applications.) If the safety analysis introduces specific requirements for Safety Class / Safety Significant and Safety Integrity Level components, the cost and schedule will extend beyond that claimed by the vendor.

2.2 Adsorption

Adsorption is one of the most widely applied control technologies for abatement of volatile organic compounds (VOCs). The adsorption process can be either physical or chemical. In physical adsorption, the chemical nature of the absorbed VOC remains unchanged with the compound held in place by weak van der Waals forces or by intermolecular cohesion. Therefore, the process is readily reversible and provides the advantage of regeneration of adsorbent due to the weaker bonding of the VOC and adsorbent material. In chemical adsorption, the volatile chemical/element becomes chemically bonded to the adsorbent, and therefore, is not amenable to regeneration. Because adsorption processes simply separate the contaminant(s) from the gas stream, adsorption processes are used in conjunction with other unit operations to recover or destroy the organic compounds or the spent adsorbent is removed and disposed. (U.S. EPA, March 2006)

The adsorbent most often used to treat off-gas VOCs is activated carbon. In addition, activated carbon can be impregnated with various compounds such as sulfur and phosphate to chemically react with volatile mercury or ammonia, respectively. The activated carbon can be in pellet, bead, granules, or powder form. Because the granular form of activated carbon is generally used as the adsorbent, the systems are referred to as granular activated carbon (GAC) systems. Activated carbon is an excellent adsorption medium because of its large specific surface area and micro-pores. Other common adsorption media include silica, alumina-based adsorbates, hydrophobic zeolites and polymers. Impregnated sorbents capture species by chemisorption whereas the materials without amendments treat the contaminated waste stream by capturing and removing the VOCs through physical adsorption. (U.S. EPA, March 2006)

Activated carbon may be either disposed or regenerated once it has reached its adsorption capacity. Once spent, the carbon in regenerable systems is treated to remove the adsorbed chemicals and allow the carbon to be used again. Regeneration is performed by changing the conditions (generally by steam or hot air) in the bed to desorb the contaminants from the carbon. Carbon can be regenerated in place or at an off-site regeneration facility.

Numerous vendors that participated in the workshop included carbon adsorption as part of their proposals as shown in Table 2-1. Some vendors selected this as the primary treatment method, others recommended its use as a final guard or polishing step, and a few included it to treat specific compounds such as mercury.

Table 2-1 Vendors that Included Adsorption in Proposed Vapor Abatement Solution

Vendor	Primary VOC Control Method	Secondary or “Polishing” Stage for VOC Removal	Mercury Control
Calgon Carbon	X		X
Hee-Duall	X		X
W. L. Gore			X
NESTEC, Inc.			X
NUCON, International		X	X
Project Integration, Inc.			X
Comi Polaris			X
Advanced Air Technologies	X		X
Bionomic Industries	X		X
B&W MEGTEC			X

2.2.1 Technical Feasibility

Well-designed adsorption systems may achieve 95 to 98 percent control efficiencies at input concentrations of 500 to 2,000 ppm_v. (U.S. EPA, CATC, May 1999) For organic concentrations above 100 ppm, carbon absorbers can achieve control efficiencies of at least 95%, which have been demonstrated in many applications. (U.S. EPA, CTC, May 1995). In theory, activated carbon can be tailor-made to remove pollutants at very low organic concentrations. However, there is great variation in control efficiencies based on performance data found in literature. (U.S. EPA, CTC, May 1995) Many factors can impact the performance of the carbon adsorption system including very low inlet concentrations, temperature, and humidity. High humidity and temperature diminishes the adsorptive ability of GAC. There is no theoretical method that consistently and accurately predicts the performance of adsorption systems. (U.S. EPA, March 2006) Carbon adsorption is based on the principle of equilibrium partitioning from the vapor phase to the surface of the carbon. The carbon adsorption capacity is strongly influenced by the contaminant concentration in the process stream and the temperature at which the adsorption is taking place. In general, the higher the concentration of contaminant in the vapor stream, the higher the contaminant adsorption capacity of the carbon. Conversely, higher temperatures result in lower adsorption capacity. Carbon manufacturers generally have adsorption isotherm data (i.e., adsorption capacity as a function of concentration at a constant temperature) for specific compounds and their specific carbon type that allows prediction of adsorption capacity when breakthrough occurs.

Inlet VOC concentrations may vary by more than an order of magnitude, but the outlet concentration from the carbon bed essentially remains constant prior to breakthrough. Other ways in which carbon adsorption systems are robust is that they are insensitive to rapid changes in VOC concentrations. Activated carbon adsorption systems can treat a wide range of VOCs, although some highly polar compounds (such as alcohols and organic acids), highly volatile compounds like vinyl chloride and methylene chloride, smaller molecules (such as methanol and formaldehyde), and sulfur compounds do not adsorb well. Hydrophilic zeolites adsorb these compounds better than GAC. (U.S. EPA, CTC, May 1995)

Adsorption systems are most effective in terms of both cost and waste management in projects involving dilute contaminant concentrations (less than 100 ppm_v) and moderate flow rates that generally range from 100 to 1,500 scfm. These relatively low concentrations may be difficult or uneconomical to meet using another technology such as thermal oxidation that would require high fuel costs to maintain combustion temperatures. For some applications, GAC systems find use with other technologies, such as thermal treatment. (U.S. EPA, CTC, May 1995)

2.2.2 Design Features

Table 2-2 lists key design consideration for carbon adsorption systems. Design of a carbon adsorption system begins with definition of the following operating factors (U.S. EPA, June 1998): concentration range of volatile organics present, range and average values for flowrate and temperature, and relative humidity. Another factor in the system design is determining the bed cross-sectional area based upon desired velocities to keep pressure drop within capacity of the fan. The working capacity depends on carbon type, temperature and humidity, concentration of specific compounds present, superficial velocity, and regeneration parameters. If the adsorbate contains multiple compounds, chemical interactions influence the working capacity. For example, more strongly adsorbed compounds displace less strongly absorbed species and push them through the bed. Fouling and flow blockage must be considered in the design. Compounds that contribute to the fouling can be solid particles, high molecular weight compounds, and compounds that chemically react on the surface of the carbon such as ketones. Safety considerations are required since ketone adsorption and heat generation pose a risk of localized heating and carbon bed fires. Other design considerations include risk of channeling. (U.S. EPA, March 2006)

Table 2-2 Design Considerations for Carbon Adsorption System

Factor	Design Considerations
Volatile Organic	Select carbon and pore size (smaller than 2X diameter of organic molecules) to result in the greatest adsorptive forces. Activated carbon is ineffective for VOCs with high polarity, such as alcohols and organic acids, or high vapor pressure compounds such as vinyl chloride or methylene chloride, or very small molecules.
VOC Concentrations	Consider reasonable time until carbon breakthrough occurs to minimize frequent carbon replacement or regeneration.
Carbon Replacement Frequency	Design system to minimize carbon replacement frequency prior to breakthrough. <ul style="list-style-type: none"> - Align two or more beds in series to prevent contaminant exceeding emission limits. - Series arrangements permit more contact time between contaminant and adsorbent and enable breakthrough monitoring of primary vessel effluent without risking contaminant releases.
Temperature and Humidity	High relative humidity >50% and temperature > 150° F diminish carbon's absorptive ability. <ul style="list-style-type: none"> - Add pre-treatment dehumidification equipment. - Although higher temperatures reduce adsorption capacity, this effect is less severe; therefore, designs sometimes incorporate a heater to reduce incoming humidity.
Linear Bed Velocities	Typically range from 15 to 100 fpm. <ul style="list-style-type: none"> - Low flows (<15 fpm) result in flow channeling in the carbon beds, - High flows (>100 fpm) result in fluidizing the carbon beds.
Performance Efficiencies	Adsorption isotherm data are available from manufacturers for many compounds; consult these during system design.
Safety & Fouling	Fouling can result from solid particles, high molecular weight compounds, and compounds that chemically react with carbon such as ketones. Safety considerations will be required since ketone adsorption is a known factor in carbon bed fires. Parallel arrangements accommodate higher flow rates and increase the overall adsorption capacity of the system and the necessary velocities. Design for water addition for heat quenching
Channeling	Occurs when off-gas bypasses areas within bed. Channeling can be minimized by baffling.

Table adapted from (U.S. EPA, June 1998).

2.2.3 Operational Considerations

Carbon adsorption systems are relatively simple abatement technologies with minimal moving parts. At a minimum, the system may be instrumented with monitoring of carbon monoxide and temperature for mitigation of bed fires, with possible safety interlocks. The needed equipment may also include backflow

preventers, check valves, and flame arrestors. Therefore, monitoring of alarms is required, either locally or remotely.

Routine maintenance includes testing set-points/interlock systems. The carbon replacement frequency is determined by both pilot-testing and empirical based modeling. The carbon may be sampled on some frequency to determine the penetration depth of the absorbed organic through the bed (i.e., the mass transfer zone), and the projected time for replacement.

2.2.4 Secondary Waste

Carbon adsorption systems generate both spent carbon and the corresponding container. The secondary waste generation rate depends upon the inlet concentrations of contaminants. Carbon vendors estimate quantity of spent carbon from modeling and pilot-testing based upon measured inlet concentrations and desired exhaust concentrations.

The carbon from off-gas adsorption treatment systems is most often taken offsite for regeneration or disposal. Less commonly, adsorbents can be regenerated on site. During regeneration, the contaminants thermally desorb and require further treatment using some other technology (usually incineration). For the current application, commercial regeneration may prove impractical or even nonviable given the risk of radioactive contaminants and the lack of precedent with the DOE complex for release of used carbon to commercial suppliers. Spent carbon designated for disposal may classify as a hazardous waste for the Hanford application due to mercury content and other considerations. If radioactive contamination occurs, the waste may classify as mixed hazardous waste.

2.2.5 Safety and Regulatory Considerations

Carbon adsorption systems are mature technologies, with potential safety issues readily identified based upon historical information. Adsorption of vapors onto activated carbon is an exothermic process. Elevated concentrations of organic compounds with high heats of adsorption on new dry beds, such as ketones, may cause carbon to auto-ignite and produce a bed fire. Therefore, the design may need fire protection measures when treating these compounds. To minimize fire potential, vendors suggest several engineering controls including: (Soelberg, May 2011)

- carbon monoxide monitoring with safety interlocks to provide early detection of carbon bed hot spots and stop air flow to prevent bed fires,
- monitoring and control of the gas flowrate through the bed to maintain adequate convective heat transfer from the adsorption process,
- monitoring and control of the inlet gas temperatures to stay well below carbon ignition temperatures, and
- system design for “wetting” the carbon bed using water and an inert gas purge to lower reactive gas concentrations and increase convective bed cooling.

Options to monitor for localized hot spots include monitoring in-bed and bed outlet gas temperatures, and more effectively by monitoring bed outlet gas CO concentrations. The design can avoid forming hot spots by providing appropriate in-bed gas velocity (to remove heat), ensuring good gas flow distribution, and by providing sufficient but not excessive bed depth. Design features may include monitoring and control of gas and bed temperatures and compositions. (Soelberg, May 2011)

The safety design may include one or more of the following controls: lowering the temperature by convectional and evaporative cooling, maintaining flow above a minimum value (dependent on inlet concentrations of constituents with high heats of adsorption), and removing oxygen from the system using nitrogen or water.

Regulatory considerations are required for disposing or releasing used carbon due to absorbed mercury and other contaminants. Disposal may necessitate use of a hazardous waste landfill or mixed hazardous

waste landfill depending on concentrations of regulated compounds on the carbon. (NOTE: The Waste Treatment and Immobilization Plant design incorporates carbon sorption in the treatment of offgas, including capture of mercury. Disposal requirements for the Tank Farms application will be similar in nature.)

2.2.6 Cost and Schedule

The capital cost of a carbon adsorption system is directly proportional to the off-gas flow rate and VOC concentration, which impacts the amount of carbon used. (U.S. EPA, March 2006) Order of magnitude cost for carbon adsorption is significantly less than that of thermal oxidizers. The capital cost includes the adsorber vessel and carbon that comprise 50 to 90% of the total equipment cost. The system will include auxiliary equipment, such as fans, pumps, and internal piping but these usually comprise a small part of the total equipment cost. Direct and indirect annual operating costs can include: steam (for systems with regeneration), cooling water, electricity, carbon replacement, operating and supervisor labor, and maintenance labor and materials. (U.S. EPA, Office of Air Planning and Standards, Jan 2002)

Fabrication of a system typically requires 6 months to 1 year from contract issuance.

2.3 Filtration or Membranes

Common industrial practice for off-gas treatment includes use of filter bags or membranes to remove contaminants. This technology is usually associated with particulate removal although membranes may also treat select contaminants by sorption or chemical reaction with material contained within the membranes. As an example relevant to the Hanford Tank Farms application, W. L. Gore & Associates (hereafter referred to as Gore) provides unique products that are specific to treatment of NO_x, dioxins/furans, and mercury.

Gore has deployed these technologies for power plants as retrofits to downstream baghouses since 1998. The baghouse consists of multiple filter bags to treat the exhaust. The Gore filter bags incorporate catalysts in an expanded polytetrafluoroethylene (ePTFE) fabric to treat NO_x, dioxins and furans. The NO_x catalyst (GORE[®] DeNO_x) requires ammonia to react with the NO_x forming nitrogen and water vapor. Dioxin and furan remediation (GORE[®] REMEDIA[®]) occurs using a different catalyst in the filter bag configuration. The catalyst reacts with the dioxins and furans to create water vapor, CO₂, and HCl. (Bryant, Xu, & Kotts, 2016)

For mercury control, Gore (GORE[®] Mercury Control System) incorporates activated carbon into an ePTFE substrate to form an adsorbent filter paper with the resulting membrane fabricated into a filter module. This form factor maximizes carbon loading while minimizing pressure drop.

A more traditional application of filtration is to control vapor emissions from a thermal oxidizer via a downstream baghouse with injection of powdered activated carbon into the filter bags. In this approach, activated or chemically treated carbon can adsorb contaminants not treated by thermal oxidation such as mercury.

Only a single vendor, W. L. Gore and Associates, included the membrane technology as a significant feature within their proposals. Project Integration also suggested a potential use but did not develop the design discussion in detail.

2.3.1 Technical Feasibility

REMEDIA[®] filter bags reportedly remove 99% of dioxin and furans from the inlet stream. Compounds such as SO₂ and phosphorous compounds will poison the catalyst. The manufacturer recommends maintaining SO₂ levels below 200 ppm and phosphorous compound levels below 500 ppm. The catalytic reaction is temperature dependent. The inlet gas temperature should be between 350°F and 400°F to achieve the rated destruction efficiencies.

DeNOx filter bags reportedly achieve destruction efficiencies up to 75%. They require addition of ammonia for the reduction of NOx. (If the inlet stream contains stoichiometric excess ammonia for the reaction, then ammonia injection is not required.) Other selective catalytic reactors report a typical ammonia “slippage” (i.e., excess unreacted ammonia exiting the process) of 10 ppm. The treatment of the Hanford waste tank vapors is a unique and complex application; initial planning should assume a similar or larger slippage. The temperature range for optimum catalytic reaction in the DeNOx filter bags is 350°F to 450°F. As with the REMDIA[®] filter bags, SO₂ and phosphorous compounds tend to foul the catalyst.

Powdered activated carbon injection can achieve mercury removal efficiencies as high as 90%. (Jones, Hoffman, Smith, Feeley, III, & Murphey, 2007) Additional enhancements occur using treated activated carbon, such as bromine or sulfur treatments (US EPA, UNEP, SERI, 2014). Removal efficiencies are driven primarily by initial concentrations of mercury and activated carbon injection rates. All three filter bag technologies assume the use of a bag house to house the filters and some form of oxidation treatment preceding it.

Mercury removal efficiency for sorbent polymer catalyst is 99% or higher and depends on the gas velocity and filter stack height (i.e., number of filter modules used). For mercury removal rates of 99% the stack height exceeds 10 feet. This technology is attractive because of the high loading capacity for mercury reported by the vendor: 2.7 lb of mercury in a 2 ft x 2 ft x 1 ft filter module.

2.3.2 Design Features

The design typically deploys filter bags and membranes within a separate baghouse, often – but not exclusively – at the end of the processing line. Deployment usually involves a large number of bags or membranes. Hence, pressure drop proves less reliable to detect either loss of integrity or excessive fouling. Hence, designs sometime rely on off-gas monitoring to identify change out frequency.

Vendors optimize the equipment design to provide high mechanical durability and long life-cycles.

2.3.3 Operational Considerations

Most applications allow for manually handling and replacement of used filter bags. However, custom designs could integrate bag-out approaches similar to those for HEPA filters albeit at higher costs.

Most operations assume inspection on a routine frequency, such as quarterly or annually. The vendor has an experience base for integrating monitoring into the design to detect failure of bags and excessive pressure drop due to plugging. Such monitoring reduces the frequency for inspections. In high dust applications, filter bag life typically reaches 6-7 years. The vendor believes the Hanford application is likely less challenging than the typically power plant deployment.

2.3.4 Secondary Waste

At end of life, the process discards used filter bags and membrane modules as debris.

2.3.5 Safety/Regulatory

Discarded filter bags or membrane modules contain deposits with trapped contaminants. The mercury content often results in a hazardous classification. For most commercial operations (e.g., power plants), precedent exist for disposal at a lined landfill.

2.3.6 Cost/Schedule

Prices vary widely depending on the application.

2.4 Thermal Oxidation

Thermal oxidation is a general term for destroying organic compounds by combustion. Oxidizers are ubiquitous in the industry because of their wide applicability to organic compounds and high destruction efficiencies. There are two types of oxidizers, thermal and catalytic. Thermal oxidizers heat pollutants to the autoignition temperature, which requires operation in the 700°C to 1500°C range for combustion. Catalytic oxidizers utilize a catalyst to lower the operating temperature at which oxidation occurs to 340 °C to 590 °C. (Oyama & Hunter, 2000)

Thermal oxidizers are either direct fired or flameless depending on the configuration of the combustion chamber. Direct fired oxidizers feed the gas into a reaction chamber heated to temperature via a direct flame. (Oyama & Hunter, 2000) Flameless is a misnomer when discussing oxidizers; the term refers to a system that premixes the fuel and off-gas prior to injection into a porous ceramic bed maintained at temperature which limits the size of the combustion zone.

Heat exchangers may be used with direct fired oxidizers to improve fuel efficiency by recovering heat from the exhaust gas to pre-heat the inlet gas. Regenerative oxidizers improve fuel efficiency even further but at the expense of potentially lower destruction efficiencies.

Flares are a type of thermal oxidizer in which the combustion reaction occurs instantaneously at the burner. Flares find frequent use in control of periodic venting of off-gas streams with high fuel value. (Oyama & Hunter, 2000) The authors did not consider flares as a viable alternative for this application due to the regulatory implications and the relatively low heat value of the off-gas. For example, treating the off-gas can generate additional NO_x without any opportunity to provide control of those emissions.

Many of the vendors interviewed by SRNL staff proposed use of thermal oxidizers for treating the off-gas from the Hanford waste tanks including NESTEC, Upstate Electrical, B&W MEGTEC Systems, John Zink Hamworthy, Alzeta, and Project Integration.

2.4.1 *Technical Feasibility*

Thermal oxidizers are widely used because they can destroy a wide variety of pollutants with a high destruction efficiency. DRE's of 99.99% are typical with some vendors claiming as high as 99.999%. (Campbell, 2016) The majority of vendors at the workshop estimated likely efficiency at the lower range value (~99.99% or less) for the Hanford waste tank off-gas. Combustion of halogenated constituents in the off-gas forms acids that pose corrosive concerns. System designs typically include caustic scrubbers downstream to neutralize these acids. Thermal oxidation does not treat elemental mercury sufficiently to meet emissions regulations, and another treatment technology is often included for this purpose.

The combustion process may form NO_x, acids, dioxin and furans as byproducts in the exhaust as the gas cools. Concentrations of nitrogen bearing compounds and halogens entering the oxidizer can provide estimates of the amount of furans and dioxins. Extensive understanding exists for the formation processes and there are multiple engineered solutions to minimize NO_x formation. Characterization of waste stream is integral to final determination of need for any subsequent treatment phases.

Catalytic oxidizers are also widely used and have high destruction efficiencies. They operate at much lower temperatures, typically 600°F to 800°F (315°C to 427°C) (US EPA, 2003), yielding lower operating costs and reduced propensity for creating NO_x. However, many compounds, including sulfur and mercury, act as a poison on the catalyst degrading its performance over time. Therefore, catalytic oxidizers are generally not considered for applications where the waste stream contains a wide variety of compounds such as present in the Hanford off-gas.

2.4.2 Design Features

While the concept of oxidation is straightforward, control of the process to ensure complete combustion and safe operation can be complex. Maintenance costs increase in relation to the increased complexity. Oxidizers do not tolerate large temperature swings or, in particular, frequent startups and shutdowns. Constant operation at temperature is a requisite for achieving the design service life due to effects caused by heating and cooling of the oxidizer components. This concern is mitigated somewhat by careful control of the temperature ramp during temperature transitions. Flameless oxidizers avoid this issue by maintaining a blanket of cool gas surrounding the burner. Depending on the VOC energy concentration of the treated off-gas the fuel costs for maintaining constant temperature can be high. For the Hanford application, manufacturers estimated typical fuel consumption figures quoted by manufacturers for direct fired oxidizers sized for an inlet flow rate of 2000 scfm as 6000 to 8000 scfh for natural gas. Most thermal oxidizer systems incorporate a water quench or alternate means to rapidly reduce temperature and minimize the formation of de novo furans, dioxins and NO_x.

These units typically require in the neighborhood of 900 to 1500 square feet. In addition to the fuel, typically propane or natural gas, they require three phase electrical power for fans and pumps, single phase power for control, instrument air, and water. Chemical reagents are needed for acid gas scrubbing.

2.4.3 Operational Considerations

Thermal oxidizers are relatively complex systems requiring monitoring and control of multiple parameters to ensure safe and reliable operation. However, the technology is mature with well documented control strategies; therefore, all the vendors surveyed include automatic control using a programmable logic controller (PLC). The process requires constant monitoring, whether local or remote. In addition, deployment requires routine operator rounds to assess physical condition of the plant on a per shift or per day basis.

Maintenance needs include routine care of rotating equipment as well as annual outages for inspection of the reaction chamber and burners. The design requires calibration of multiple instruments on an annual basis. Overall, these types of systems represent a significant load on maintenance resources.

2.4.4 Secondary Waste Generation

Thermal and catalytic oxidizers are attractive because a well-designed system, in which complete combustion is assured, can have residuals of less than 0.001%. Thermal oxidizers have the potential to create NO_x as well as furans and dioxins in the exhaust gas that may require additional treatment. In addition, oxidation of halogenated compounds will create acids in the exhaust, which may also require treatment. For the reasons stated, many manufacturers recommend the use of a wet scrubber as a post-oxidation treatment.

2.4.5 Safety and Regulatory Consideration

The safety considerations for deploying thermal oxidation units in the Hanford Tank Farms include, but are not limited to, the following considerations.

- Nuclear Safety – Thermal oxidizers require fuel delivery systems and fuel quantities in excess of current tank farm permitted limits (i.e., 5 gallon containers) and location in close proximity to the tanks.
- Combustion Off-gas Products: Generation of NO_x and Products of Incomplete Combustion – The treated off-gas from the oxidation process may contain undesirable byproducts such as nitrogen oxides (NO_x) or sulfur oxides (if sulfur compounds are burned).

2.4.6 Cost and Schedule

Capital costs for thermal oxidizers are generally high compared to other technologies. Estimates from the vendors surveyed range from \$1 million to \$10 million. The large range of values for cost reflect variance in the assumptions made by the vendors for size of the oxidizer and additional treatment phases provided. The energy concentration, or fuel value, of the waste stream organic constituents as well as the thermal inertia of the gas determine the fuel costs. Oxidizers generally show greater cost effectiveness, compared to other abatement technologies, if the inlet VOC concentration exceeds 1500 ppm.

2.5 Absorption

Gas absorption, or wet scrubbing, processes remove volatile chemicals from a gas stream by transferring them to a liquid (i.e., solvent). Removal of the chemical vapors occur by absorption into a liquid or by reaction with a liquid sorbent or slurry. The liquid most commonly used in wet scrubbing is water, which effectively treats only water-soluble compounds such as low molecular weight alcohols. Other solvents such as acids are used to react with inorganic vapors in the waste stream. Solvents, such as nitric or phosphoric acid, are used to react with various inorganic compounds such as ammonia, amines, and nitrous oxides. Wet gas scrubbing as a vapor control technique is much more commonly employed for inorganic vapors (e.g., hydrogen sulfide, chlorides) than for organic vapors. (Moretti, 2002), (U.S. EPA, CTC, May 1995)

A properly designed gas absorber provides thorough contact between the gas and solvent to facilitate diffusion of the volatile chemicals. The rate of mass transfer between the gas stream and the solvent largely depends on the surface area exposed and the time of contact. Contact between the absorbing liquid and the vent gas is accomplished in counter current spray towers, scrubbers, or packed or plate columns to provide enhanced liquid-vapor contact area necessary to facilitate mass transfer. Packed bed packing material improves vapor-liquid contact while spray scrubbers are designed with nozzles to atomize the liquid solvent to provide large surface area for the liquid-vapor contact. (Khan, 2000) Other factors governing the absorption rate that do not depend on the equipment include the solubility of the gas in a particular solvent and the degree of chemical reaction between the constituents. The vendors that recommended scrubbing control technologies for abatement of the Hanford Tank Farm off-gas used both spray or packed bed scrubbers in their recommended approaches. (U.S. EPA, Office of Air Planning and Standards, Jan 2002)

Use of absorption as the primary control technique for VOCs is limited by several factors. First, the compounds must be soluble in the scrubbing solvent. Availability of vapor-liquid equilibrium data for the specific compounds and the solvent system is necessary for design of the system; however, data is not readily available for uncommon organic compounds. (Moretti, 2002)

Another consideration in the application of absorption is treatment or disposal of the liquid scrubbing wastewater. This wastewater must be treated and disposed or permitted for outfall release. In addition, the low outlet concentrations typically required in organic air pollution control applications often lead to impractically tall absorption towers, long contact times, and high liquid-gas ratios that may not be economically viable. However, for inorganic compounds not controlled by thermal oxidation or adsorption, absorption can achieve extremely low outlet concentrations. (U.S. EPA, CTC, May 1995)

Three vendors (i.e., HEE/Duall of CECO Environmental, Advanced Air Technologies, and Comni Polaris) proposed wet scrubbing as a primary treatment technology for the inorganic constituents (i.e., ammonia, amines, water-soluble mercury species or NO_x) in Hanford tank farm off-gas. Other vendors (i.e., ALZETA/Anguill and NESTEC) suggested wet scrubbing for removal of acid gases from a proposed thermal oxidizer.

2.5.1 Technical Feasibility

Absorption systems can achieve good removal efficiencies, in excess of 90%, but again, vary for each pollutant-solvent system and with the equipment design used. Absorption finds wide use in applications containing high concentrations of VOCs. However, the more common use is for controlling inorganic gases. For VOCs, absorber removal efficiencies are normally low for relatively insoluble compounds at low concentrations; higher efficiencies occur for off-gas with readily soluble compounds at high concentrations. A wet scrubber's removal efficiency is directly related to the amount of energy expended in contacting the gas stream with the scrubber liquid and the liquid-vapor equilibrium adsorption isotherms. Most absorbers have removal efficiencies in excess of 90%, and packed tower absorbers may achieve efficiencies greater than 99% for some pollutant-solvent systems. Table 2-3 provides the collection efficiency ranges for various scrubber types and pollutant types. (U.S.EPA, 2003-1)

Table 2-3 Vendors that Included Adsorption in Proposed Vapor Abatement Solution

Wet Scrubber Type	Inorganic Gases	VOCs	SO ₂
Spray Chamber Tower	> 90%	50% to 95% ⁽¹⁾	80% to 99%
Packed Bed/Packed Tower	95% to 99%	70% to 99% ⁽¹⁾	not available
Impingement-Plate/ Tray Tower	95% to 99%	not available	80% to 99%

⁽¹⁾ Low efficiencies are for insoluble vapors at low concentrations and high efficiencies are for soluble compounds at high concentrations.

Industry most commonly uses absorption processes for control of specific inorganic compounds such as acid gases and nitrous oxides not removed by other technologies such as thermal oxidation or carbon adsorption. Consequently, absorption processes normally serve as a secondary control technology downstream of incinerators that generate acid gases and other inorganic compounds. Examples of inorganic compounds removed in scrubbers include chromic acid, hydrogen sulfide, ammonia, amines, chlorides, fluorides, and SO₂. For example, six participating workshop vendors proposed scrubbing technologies for control of inorganic vapors in the Hanford Tank Farm application. Scrubbers with water solvents will control gaseous streams that have high concentrations of water-soluble VOCs such as alcohols (methanol, ethanol, isopropanol) and acetone and formaldehyde. Little data exists on using scrubbers as a primary VOC control technology for gas streams with the wide variety of chemical groups as the Hanford Tank Farm application and at low average concentrations. None of the participating workshop vendors proposes using scrubbing as a primary VOC control technology. (U.S.EPA, 2003-1)

2.5.2 Design Features

Wet scrubbers are normally vertical chambers (spray, packed tower, and sieved tray) whose design depends on the gas flows and contact time needed for the absorption to occur. They are equipped with tanks containing the absorbent or reagent, normally under recirculation. Instrumentation required to monitor operation may include pressure differential, temperature differential (for some high temperature applications), and scrubber liquid flow rate. Other monitoring needs may include gas flow rate, scrubber liquid solids content, and scrubber liquid makeup or blowdown rates. Crucial design features of the scrubber design may include the atomizing spray nozzles required to spray continuously liquid droplets as small as 10 microns into the chamber. Nozzle design is crucial to providing a very high surface area between the gas and liquid interface.

Design considerations for the absorption system are based upon the off-gas stream characterization. Specifically, characteristics requiring consideration are air flow, temperature, pollutant loading, as well, as the following. (U.S.EPA, 2003-1)

- Air Flow: Typical gas flow rates (for spray towers) are 1,500 to 100,000 scfm.
- Temperature: In general, higher gas temperature yields lower absorption rates, and vice-versa. Excessively high gas temperatures can lead to significant solvent or scrubbing liquid loss through

evaporation. For gas absorption applications, the temperature normally ranges between 40 and 100 F. Designs frequently need pre-coolers (e.g., an additional spray chamber) to reduce temperature of the inlet air.

- Pollutant Loading: Typical gaseous pollutant concentrations range from 250 to 10,000 ppm_v. Spray tower wet scrubbers are not as prone to fouling as other wet scrubber designs, but may require very high liquid-to-gas ratios.

2.5.3 Operational Considerations

Wet scrubbing systems are relatively simplistic control technologies equipped with a recirculating pump system and instrumentation (e.g., temperature, flows) for performance monitoring. Most vendors provide automated startup, operation, and shut down via PLC or similar control system. Monitoring of instrumentation can occur locally or remotely. Remote monitoring necessitates routinely scheduled operator rounds to assess physical condition and local indicators.

Wet scrubbing systems are susceptible to several operating problems. The most common of these include inadequate liquid flow, liquid re-entrainment, poor gas-liquid contact, corrosion, and plugged nozzles, beds, or mist eliminators. Therefore, annual maintenance is recommended. Normally, instrumentation readings will provide notification of required maintenance but annual inspections of spray nozzles and packed tower beds will be required.

2.5.4 Secondary Waste

Scrubbers generate liquid scrubber wastewater that requires treatment and disposal or discharge. The generation rate for the liquid wastewater depends on the inlet concentrations or removed compounds. At normal design concentrations, the scrubbing liquid recirculates and will only require “blowdown” when the salts reach a certain limit set to minimize accumulation as solids and plugging in the system. Participating vendors provided rough estimates of scrubbing wastewater generation of 0.5 gpm per scrubber. The scrubbing liquid waste will consist of various salts, dissolved organics, and mercury.

2.5.5 Safety and Regulatory Considerations

Absorption is a mature control technology with potential safety issues readily identifiable based upon historical information. Absorption systems pose potential hazardous operations involved in chemical handling of scrubbing liquids such as sulfuric acid, sodium hypochlorite, and sodium hydrosulfide. This assessment did not identify any nuclear safety concerns for the Hanford Tank Farm off-gas application.

Environmental permitting considerations include treatment/disposal or release of the scrubbing wastewater and the use of additional chemicals as scrubbing reagents (e.g., sulfuric acid, sodium hypochlorite, etc.).

2.5.6 Cost and Schedule

Vendors participating in this technology assessment did not provide any cost information. Order of magnitude cost estimates from industry for the scrubber and supporting systems are relatively low. A ROM cost when considering all the necessary pipes, tanks, instrumentation, and absorption stages could range from \$500,000 to over \$1.0 million for the total capital investment for common commercial (i.e., non-nuclear). The EPA air pollution control cost manual (U.S. EPA, Office of Air Planning and Standards, Jan 2002) estimates the cost of a fiber reinforced plastic packed bed scrubber, including necessary support equipment and instrumentation, at over \$300,000 for an industrial application with off-gas flows exceeding 20,000 scfm.

Operating costs of absorption processes are essentially independent of concentrations of contaminants because the energy needed for circulation and heating of the absorbent depends primarily on the volume of absorbent.

Fabrication, delivery, and installation of a system are projected to require 6 months to 1 year from contract issuance.

2.6 Non-Thermal Destruction

Non-thermal destruction refers to the use of plasmas or ultraviolet (UV) light to create free radicals which oxidize contaminants. The use of plasma for pollution control is common in Europe where it is often used for odor abatement. In the US, ultraviolet plasmas are more commonly marketed for use in medical and food industries. The process is attractive because it is energy efficient and rapid.

Plasmas are characterized as thermal and non-thermal. In thermal plasmas the entire gas is in local thermal equilibrium which can be at temperatures greater than 10^4K . Non-thermal plasmas are characterized by a bulk gas temperature at or near ambient. The type of plasma generated is controlled by the electrical current flowing through the plasma and the frequency of the applied voltage. Plasmas in which the bulk gas temperature is elevated, but not in equilibrium, are sometimes termed translational plasmas. Examples of methods for generating non-thermal plasmas are barrier discharge, corona, and plasma jet. Examples of methods for generating translational plasmas are gliding arc, plasma torch, and microwave torch. (PlasTEP, 2012) In general, the more energetic the plasma, the more aggressive the contaminant destruction. Plasmas from ultraviolet light tend to be less energetic than other non-thermal plasmas.

In processes using ultraviolet light, the primary mechanism for pollutant destruction is generation of highly active radicals such as O^\cdot , OH^\cdot , HO_2 , and ozone. These radicals break down gas molecules, primarily through oxidation, creating CO , CO_2 , H_2O , and other partial oxidation products. The process is complex and highly dependent on the gas mixture as well as the temperature. Therefore, while DREs as high as 99.99% have been reported in the literature, (Dean, 1997) destruction efficiency and secondary waste determination for complex mixtures are often determined empirically.

Two vendors, Schenck and HGI Industries, proposed treatment approaches for the Hanford tank farm off-gas based on non-thermal oxidation.

2.6.1 *Technical Feasibility*

Non-thermal methods are an attractive technology because they are theoretically more efficient at destroying pollutants and easily controlled. Theoretical efficiencies are gained because less energy is lost in heating the bulk gas versus thermal oxidation where the bulk gas temperature is raised substantially to break the chemical bonds. Because the ultraviolet free radical generation process is electrical in nature, it can be rapidly turned on and off without undue stress to the equipment. However, plasma decomposition is less universal, than thermal oxidation, in the compounds destroyed and less aggressive overall.

Ultraviolet systems tend to generate more NO_x than they destroy and do not treat elemental mercury. The method will degrade organo-mercury compounds but the authors did not locate any data on the efficiencies. Non-thermal plasmas generally treat NO via chemical reaction to create NO_2 while NO_2 treatment generally requires a catalyst. (Telebizadeh, et al., 2014) A notable exception in the treatment of NO_x is electron beam technology. These systems are marketed to the power industry for the treatment of sulfur oxides and NO_x in flue gas. (Chmielewski, Licki, Pawelec, Tyminski, & Zimek, 2004)

Although not as aggressive at destroying VOCs as oxidation, non-thermal destruction does not require hydrocarbon fuels. Therefore, the technology offers an advantage over thermal oxidation in the Hanford tank farm application where the use and storage of hydrocarbons in the vicinity of the tanks present a nuclear safety hazard. In industry, non-thermal plasma often supplements other technologies and make them more efficient. For instance, non-thermal plasma is incorporated into carbon adsorption beds to

destroy the compounds captured in the carbon pores creating a “self-cleaning” action that prolongs carbon bed life.

These non-thermal technologies will not treat the full ranges of COPCs. Designs will need to incorporate supplemental technologies to address the NO_x gases. In some instances, polishing may be needed for residual organics.

2.6.2 Design Features

The plasma technologies require higher power supplies, in the range of 5 to 30 kW, than the other technologies assessed. The ultraviolet technology uses conventional, 120V electrical systems.

Ambient temperature is assumed for the gas inlet.

With the intense, localized energy generated, the equipment is typically compact and requires modest space for most applications.

2.6.3 Operational Considerations

Non-thermal systems are simple to operate. They do not require a high level of monitoring to maintain safe operations. Monitoring for alarms is assumed, either locally or remotely. Remote monitoring necessitates regular operator rounds to assess physical condition and local indicators, nominally daily.

Some designs, may require a high level of maintenance due to the relatively short operational life of components (e.g., light bulbs or electrodes).

The process may generate and deposit particulates in the reaction chamber depending on the gas components and conditions. Periodic inspection and cleaning is therefore required.

2.6.4 Secondary Waste

Some compounds may create secondary waste such as NO_x, formaldehyde, and acetaldehyde. Ammonia may form salts depending on the concentration of acids in the gas. Ultraviolet systems may create additional NO_x.

2.6.5 Safety and Regulatory Considerations

The risks associated with this technology are well known and controls for hazard mitigation well defined and codified. This technology does not introduce any new hazards in respect to nuclear safety. Environmental permitting will be required.

Implementation of the proposed HGI Industries strategy may not align with current environmental permitting strategies because vapors in the tank headspace will be recirculated through the equipment and back into the tank.

2.6.6 Cost and Schedule

The vendors did not provide costs for a system of this type but it is believed the cost is moderate relative to other technologies considered. Delivery times differ by manufacturer. Some manufacturers maintain their equipment as commercial off-the-shelf such as the units provided by HGI Industries. Others are more likely to build to specification. Therefore, fabrication time is more vendor specific than for some of the other technologies evaluated.

2.7 Condensation

Cryogenic condensation, as the name suggests, cools the vapors until they condense from the carrier gas. Liquid nitrogen is generally used because the low boiling temperature (-170 °C) is below that of almost

all VOCs. At its simplest design, the system consists of a counter-current heat exchanger and condensate tank. The technology is an especially attractive abatement option in cases where the recovered solvent has economic value or the gaseous nitrogen is useful in other processes. (Linde North America, Inc, 2016)

Only a single vendor, Comi Polaris, included this technology as a feature within their proposals.

2.7.1 Technical Feasibility

Cryogenic condensation is often used in the dry cleaning and pharmaceutical industries where the solvents are recycled. Cryogenic condensation is attractive because the recovered solvent is uncontaminated by water or other recovery agents. The technology is best suited for low flow, less than 3000 scfm, (Comi Polaris Systems) and high concentration, greater than 1 vol %. (Dwivedi, Gaur, Sharma, & Verma, 2004) This range flow rates compare favorably with the Hanford application but the offgas VOCs concentration is well below the 1 vol % range.

A condensation system can potentially condense all of the VOCs down to a few ppm. In multi-component systems, the temperature at which the system operates is a function of the vapor-liquid equilibrium of the most volatile compound. The approach can treat ammonia but the efficiency is determined empirically due to the other components in the gas stream. The vendor has no experience with gas streams containing mercury and the authors did not find references in the literature to the effects of mercury contamination. The effects of mercury accumulation in the equipment and disposal of the condensed mercury liquid need addressed.

2.7.2 Design Features

A typical system for a waste stream of 2000 scfm would have a footprint of 88 ft² and be 36 ft tall. To mitigate frosting and fouling of the heat exchanger, designs use a dual heat exchanger system with one condensing liquids while the other is heated to remove buildup. Normal configuration treats off-gas at near ambient temperature.

The design requires pre-conditioning of the off-gas to minimize the water content prior to the cryogenic stage.

Design must include provision for liquid nitrogen supply along with instrument air and instrument power.

2.7.3 Operational Considerations

Operation of the heat exchangers requires no moving parts other than valves for switching and a blower for creating flow through the unit. Automated start up, operation, and shut down occurs via PLC or similar control structure. Monitoring for alarms is needed, either locally or remotely. Remote monitoring necessitates regular operator rounds to assess physical condition and local indicators, nominally daily.

Assuming gas flow from the Hanford tank farms of 2000 scfm, the estimated liquid nitrogen consumption ranges from 30 scfm to 130 scfm.

Due to the low temperatures, solids will accumulate over time, especially if the off-gas contains water vapor or compounds with relatively low vapor pressures. The solids reduce the efficiency of the system; therefore, the design must accommodate periodic removal of the solids.

2.7.4 Secondary Wastes

The system condenses the vapor contaminants to a liquid that must be further handled. A potential approach for final disposition to couple with condensation is a solidified waste form for landfill disposal. Another option may be shipment offsite to a commercial incinerator or treatment facility. However, such offsite treatments increase the complexity for regulatory approval, add transfer costs, and likely delays

implementation. Alternatively, the design may incorporate a downstream technology to oxidize these materials.

2.7.5 Safety and Regulatory Considerations

Safety analysis needs to assess the implications with vessels containing the condensed organic vapors. The analysis should consider the fire hazard for the collected organics.

This technology poses novel aspects for environmental permitting at Hanford. Recycle of organic condensates is not a standard practice in the DOE regulatory environment.

2.7.6 Cost and Schedule

Capital expenditures will be relatively high. A cost analysis of liquid nitrogen would be required to determine most cost effective approach to providing the large volumes required. Schedule planning should assume fabrication of a unit within 6 months to 1 year from issuance of contract.

2.8 Aerosol/Particulate Control

Electrostatic precipitators (ESP) control sub-micron aerosol and particulates in gases. ESPs impart a negative charge to the solid or liquid particles via a corona discharge. An oppositely charged plate traps the charged particles. Designs of ESPs differ primarily by the manner for removal of the collected particulates. Dry ESPs use vibration to shake the particulates loose allowing them to drop into a collector. Wet ESPs use water and, generally, a detergent to loosen and collect the particulates.

2.8.1 Technical Feasibility

Electrostatic precipitators do not remove anything in the gas phase and, therefore, do not have a direct application for the Hanford tank farm vapors. Some of the previously discussed technologies do generate fine mists of particulates that may benefit from the application of an ESP to minimize secondary wastes. However, no supplied vendor proposals recommended use of ESPs in their submittals.

2.8.2 Design Features

Inlet gas temperatures should be below 200°F. Process requirements need more definition to allow a vendor to assess the need and, subsequently, size of a unit. Dry ESPs require electrical power. Wet ESPs require electrical power and water.

2.8.3 Operational Considerations

Electrostatic precipitators are a mature technology with few moving parts. They do not require a high level of monitoring to maintain safe operations. Monitoring for alarms occurs either locally or remotely. Remote monitoring necessitates regular operator rounds to assess physical condition and local indicators, nominally daily.

The equipment requires standard maintenance protocols for rotating equipment (i.e., blowers and water pumps) and instrument calibration. The volume of maintenance will vary somewhat by manufacturer and final design input but it will be moderate.

2.8.4 Secondary Waste

The particulates collected in the ESP require disposal. The form of that disposal would depend on the chemical nature of the particulates. For example, when used with plasma technologies and ammonia injection, the waste is often sold as fertilizer, which is not a viable option for the Hanford application.

2.8.5 Safety and Regulatory Considerations

These technologies are passive and the risks to personnel safety are minimal. These technologies do not introduce any new hazards in respect to nuclear safety. The particulate waste form will need assessed for environmental permitting.

2.8.6 Cost and Schedule

Capital costs for an electrostatic precipitator can be high. However, operating costs are relatively low which makes them attractive as an industrial solution. Units are typically designed and fabricated to order; therefore, a delivery time of 6 months to 1 year from contract issuance is a reasonable expectation.

2.9 Biodegradation / Biofiltration

Biodegradation uses microorganisms to break down the VOCs. When the design contains the organisms on a solid substrate, the system is termed a biofilter. If the organisms are contained in a recirculating liquid, the system is termed a bioscrubber. The solid material in a biofilter is primarily a substrate on which the microorganisms live. If the substrate is organic, it may contain many of the nutrients needed to maintain the biomass. (Oyama & Hunter, 2000)

Biodegradation has been widely used for VOC abatement and odor control since the 1970's. (Anit & Artuz, n.d.) It is widely used in the wastewater and sewage industry but has found application in a wide range of industries including the paint, pharmaceutical, and petrochemical industries.

2.9.1 Technical Feasibility

The SRNL authors contacted several vendors to discuss the use of biodegradation. Each recommended thermal oxidation over biodegradation for the Hanford tank farm vapors application. Issues contributing to their recommendations included the broad range of contaminants some of which were not candidates for biodegradation, potential poisoning of the microorganisms by some of the contaminants and, the high destruction efficiencies desired.

2.9.2 Design Features

Optimum temperature for the microorganisms is typically between 30°C to 40°C.

Addition of lime often aids in maintaining pH in the presence of acid gases.

Microbes cannot degrade contaminants that are insoluble in water.

2.9.3 Operational Considerations

These systems are passive in nature but require monitoring to ensure health of the microorganisms.

The design needs water to ensure the bed does not dry out (biofiltration) or to replenish volume lost to evaporation (bioscrubber).

2.9.4 Secondary Waste

Designs must accommodate periodic removal of biomass from microorganism growth.

2.9.5 Safety and Regulatory Considerations

These technologies are passive and the risks to personnel safety are minimal. These technologies do not introduce any new hazards in respect to nuclear safety. Environmental permitting will be required.

2.9.6 Cost and Schedule

The authors did not investigate capital and operating costs for these systems.

3.0 Vendor Proposals

Thirteen vendors submitted proposals and participated in the workshop. An additional three vendors encountered scheduling conflicts. The SRNL authors facilitated conference calls with these vendors after the workshop, inviting all the members of the evaluation team to participate. For all 16 vendors, the SRNL authors conducted preliminary “interviews” prior to the workshop via telephone calls and e-mail interchanges. This section provides detailed discussion of those 16 proposed treatment approaches, relying on all of the discussions and interchanges.

In addition to these vendors, the SRNL authors also contacted a number of other vendors. Appendix B contains a full list of the vendors. Typically, these vendors elected to withdraw from consideration and not participate in the workshop.

One vendor, Upstate Electrical, originally planned to participate in the workshop and provided information for a proposed treatment coupling a fluid bed adsorption / desorption unit with a thermal oxidizer. Appendix E provides discussion of that proposal.

3.1 Calgon Carbon

Calgon Carbon’s proposed technology solution uses adsorption technologies consisting of both GAC for organic removal and chemically-treated activated carbon for removal of elemental mercury, formaldehyde, and ammonia. The various carbon types recommended for the Hanford Tank Farm application are:

- GAC for removal of organic species (including organic mercury compounds); and
- Chemically treated activated carbon including:
 - AMMONASORB[®] II for removal of ammonia,
 - FORMASORB[®] for removal of formaldehyde, and
 - HGR[®] for removal of mercury (elemental and oxides).

Figure 3-1 shows the conceptual approach for providing multiple stages of adsorption for the Hanford application. The figure does not include pipes, monitoring instruments, inlet gas conditioning, and other design elements.

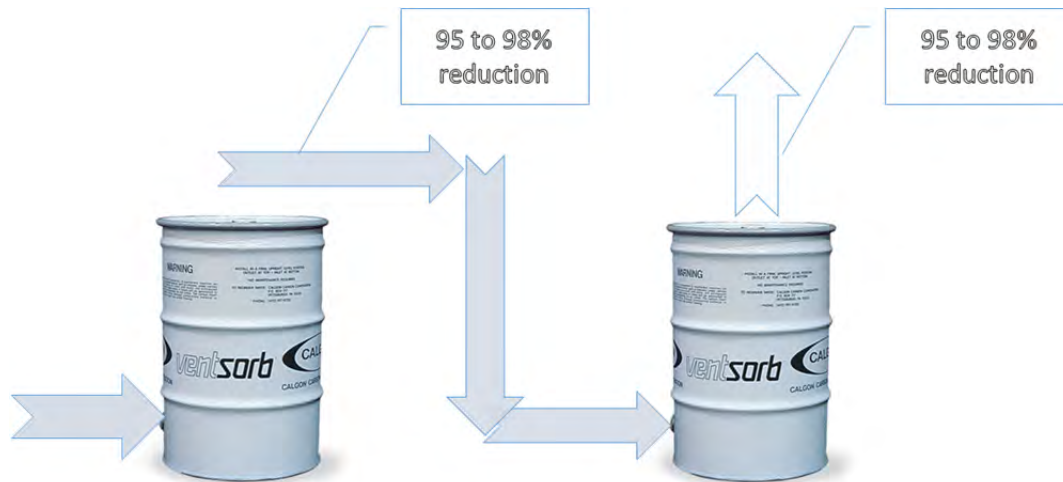

Figure 3-1 Two-stage Calgon Carbon VENTSORB[®] System.

3.1.1 Technical Feasibility

The carbon adsorption technology proposal is designed to remove all of the targeted Hanford Tank Farm COPC groups except: NO_x, some furans (e.g., the vendor indicates weak sorption for 2,3-dihydrofuran and 2,5-dimethylfuran), and a few VOCs (e.g., butyl nitrate, methyl nitrate, and nitrous oxide). The design would need additional technologies to control these species, if necessary. Table 3-1 includes vendor-provided efficiencies for the targeted groups.

Table 3-1. Calgon Carbon Technology Estimated Removal Efficiencies of Hanford COPC Groups

Calgon Carbon's Proposed Technology Strategy	VOCs	Dioxins/ Furans	NO _x	Ammonia	Mercury
Absorption					
Granular Activated Carbon (VOCs, Organic Hg)	99% VOCs	99% ⁽¹⁾			
AMMONASORB [®] (Ammonia)				99% ⁽³⁾	
FORMASORB [®] (Formaldehyde)	99% Formaldehyde				
HGR [®] (Mercury)					0.01ug/Nm ³ ⁽²⁾
Total					
Adsorption	99%	99% ⁽¹⁾		99% ⁽³⁾	0.01ug/Nm ³ ⁽²⁾

⁽¹⁾ Some furan compounds (e.g., dihydrofuran) are not removed effectively.

⁽²⁾ Based on relative humidity ≤50%

⁽³⁾ Based on ammonia concentrations up to 100 ppm.

Calgon Carbon indicated that the system can achieve 99% removal of the targeted groups (by placing deeper beds and more units in series). To determine the design configuration, the vendor said the project should provide nominal compositional information for the gas stream, preferably with no more than about 20 representative species stating initial and target final concentrations. Calgon Carbon can use proprietary software and historical treatment databases to estimate the (competitive) removal behavior and select the bed sizes. The vendor provided isotherms for selected COPCs from the various chemical groups including benzene, methyl isocyanate, N-nitrosodimethylamine, tetrahydrofuran, and polychlorinated biphenyl as representative constituents from the Hanford COPCs. The vendor uses the isotherms to determine the volume of carbon needed for a specific application.

Although the vendor has high confidence in estimating performance, they recommend a field demonstration with a pilot case as the most efficient means to select final design. The vendor does not recommend laboratory testing as sufficient due to scale up issues and risk of lack of representative simulated vapor composition. Calgon Carbon recommends pilot testing using “test” drums (e.g., VENTSORB[®] or High-Flow VENTSORB[®] containers with 180 or 3000 lb carbon with a nominal pressure drop of 4 psig at 100 to 3000 scfm) to validate the removal efficiencies and to determine when “breakthrough” of the vapors occurs. Systematic sampling and analysis of results will allow determination of carbon usage, performance and economics.

Piloting will also lead to final design for protecting the beds from moisture. Moisture control is essential to avoid water collecting in the sorbent bed and blinding the active surface from contacting the gaseous species.

3.1.2 Design Features

A system to treat 3000 scfm would require ~3000 lb. With the range of drum sizes available, and allowing for redundant drums for each sorbent type (if necessary), as few as 6 High Flow VENTSORB[®] containers may suffice for treating a group of (nominally) 8 waste tanks. The collective drums can fit in a single SeaLand container for use. In discussions, the vendor suggested that the design may accommodate the elevated “bolus” concentrations by inclusion of additional containers in series.

Pipelines should include provisions for flow and pressure monitoring to identify any occurrences of bed plugging due to collected water and significant particulate formation.

The system requires inlet gas conditioning in the passively ventilated systems including heating (approximate increase of 20° F) to reduce the relative humidity to less than 50% for maximum absorption

efficiency. Use of a demister on inlet may prove necessary. Installation after HEPA filtration will mitigate risk of particulate carryover. Exhaust fans, providing the extra benefit of fugitive emission mitigation, will draw tank vapors through the carbon bed system.

Table 3-2 provides a summary of key design features.

Table 3-2. Design Features of Calgon Carbon Adsorbent System

Design Features	Comments
Infrastructure Requirements	
Footprint of System	Likely the size of a single SeaLand container or housing multiple containers
Utilities	Water, electrical
Passively Ventilated Tanks	Integration of ventilation system of single-shell tanks in tank farm
Operating Parameters	
Carbon Beds	
Relative Humidity	Relative Humidity: < 50%
Air Flows:	System designed to achieve linear bed velocities (8-100 fpm)
Temperature	Recommended < 150°F
Pressure Drops	TBD based on carbon bed design; can be as low as 4 psig per drum
Additional Equipment Required (for Passively Ventilated Tank Farm)	
Exhaust Fans	Eliminates fugitive emissions and draws gases through system; assume HEPA filtration prior to inlet
Mist Eliminator	Removes entrained liquid prior to entering carbon beds
Reheater	Recommended 20°F increase to reduce relative humidity to $\leq 50\%$

3.1.3 Operational Considerations

The proposed system is relatively simple. The design assumes monitoring of alarms either locally or remotely. Remote monitoring necessitates periodic operator rounds to assess physical condition of equipment. Maintenance is low consisting primarily of routine maintenance of the blower and demister/reheater and periodic calibration of instrumentation. Periodic carbon sampling is advisable to assess carbon loading and predict breakthrough.

Replacement of carbon occurs on a routine basis based upon predicted performance and monitoring of emissions. The vendor will determine the system based on the expected contaminant loading and desired replacement frequency. A cost/benefit analysis by the project will identify the disposal path for the used carbon, assessing regeneration and reuse versus sealing and disposal as waste.

3.1.4 Secondary Waste

The proposed Calgon Carbon adsorption system will generate spent carbon in the associated container. The secondary waste generation rate depends upon the inlet COPC concentrations. Calgon Carbon can determine the quantity of spent carbon generated from modeling once the project provides measured inlet concentrations and desired exhaust concentrations. However, Calgon Carbon recommends pilot testing to provide data to validate the spent carbon generation rates.

Commercial regeneration may prove nonviable given the risk of radioactive contaminants and the lack of precedent with the DOE complex for release of used carbon to commercial suppliers. Although Calgon Carbon provides regeneration services, they cannot accommodate carbon with radioactive contaminants.

3.1.5 Safety/Regulatory

As part of design, Calgon Carbon would conduct a hazard analysis for the specified gas composition and provide recommended safety system interlocks in the design phase, as warranted. Safety analysis will

need to consider risk of carbon bed fires although Calgon Carbon stated the risk appears minimal for the concentration ranges in the Hanford off-gas. If the analysis indicates need for fire protection, Calgon Carbon typically recommends monitoring of both carbon monoxide as an early warning system and temperature as an indicator of “hot spots” in the carbon bed. They also recommend designing the system with liquid water sprays for evaporative cooling as a corrective action or as a preventative action to provide a cooler environment upon start-up when temperatures can be the highest. The design could also incorporate inert gas (nitrogen) injection to reduce system oxygen concentrations, as well as, maintain a minimum flow rate to ensure adequate convective cooling.

The design may also incorporate one or more of the following controls: lowering the temperature by convectional and evaporative cooling, maintaining a minimum flow (based on inlet VOC concentrations), and removing oxygen from the system using nitrogen or water.

The potential nuclear safety hazard is risk of a bed in the sorption bed. The vendor believes this hazard has low probability for the stated composition ranges but the safety analysis needs to assess that risk.

Used carbon designated for disposal may classify as a hazardous waste or mixed hazardous waste for the Hanford application due to mercury content, radioactivity and other considerations. Similar disposition needs exist at Hanford for the High Level Waste and Low Activity Waste vitrification facilities whose design includes use of carbon absorption in treatment of the melter off-gas.

3.1.6 Cost/Schedule

Calgon Carbon did not provide a budgetary estimate for a treatment system. They recommended pilot testing their smallest available system, known as VENTSORB™, consisting of a modified 55-gallon drum filled with 180 pounds of carbon that can accommodate 100 cfm. The cost for a single VENTSORB™ drum is approximately \$700 allowing relatively inexpensive testing. Additional costs include provisions for gas conditioning (reheat for passive system to reduce relative humidity) for passively ventilated tanks, engineering/administrative safety controls and inlet/exit gas monitoring.

The schedule for design and fabrication of a pilot unit or a full-scale treatment system is relatively short, and constrained primarily by the associated site engineering and safety analysis efforts. The vendor effort likely requires no more than 3 months to deliver the carbon and containers after order placement.

3.1.7 Summary Rating

The Calgon Carbon proposal is based on mature technology and addresses a robust range of the COPCs with estimated high removal efficiencies. The system is a low-cost, relatively simple design with minimal moving parts and low maintenance requirements. The vendor anticipates low generation rate of spent carbon secondary based upon estimated average Hanford COPC concentrations. The authors deem the proposed design as sufficiently mature to proceed to pilot testing. Table 3-3 provides a summary of the evaluation of the Calgon Carbon’s proposed carbon adsorption system using the evaluation criteria and metrics in the Introduction.

Table 3-3. Summary of Calgon Carbon’s Adsorption System Evaluation

Evaluation Criteria	Rating
<i>Technical Feasibility</i>	
<i>Design Features</i>	
<i>Operational Considerations</i>	
<i>Secondary Waste</i>	
<i>Safety/Regulatory</i>	
<i>Cost / Schedule</i>	

3.2 HEE/Duall

HEE/Duall of CECO Environmental proposed technology solution for abatement of the Hanford Tank Farm COPCs uses both absorption and adsorption technologies consisting of a three stage wet scrubber system with a polishing carbon bed system. The unit operations consist of the following sequential stages.

- Acid Gas Scrubber (sulfuric acid) to remove ammonia, amines, and water-soluble mercury compounds
- Oxidation Gas Scrubber (sodium hypochlorite) to remove furans and convert nitrous oxide (N₂O)/nitric oxide (NO) to nitrogen dioxide (NO₂)
- Reduction Gas Scrubber (sodium hydrosulfide) to reduce nitrogen dioxide to nitrogen gas
- Carbon adsorption to remove mercury and balance of VOCs. The carbon types include GAC for VOCs and sulfur impregnated carbon for removal of elemental mercury and mercury oxides.

The design calls for gas conditioning prior to the carbon bed stage through the use of mist elimination and gas heating to reduce the relative humidity. Exhaust fans, providing the extra benefit of fugitive emission elimination, will draw tank vapors through the system. Figure 3-2 shows the HEE/Duall three-stage scrubbing system.

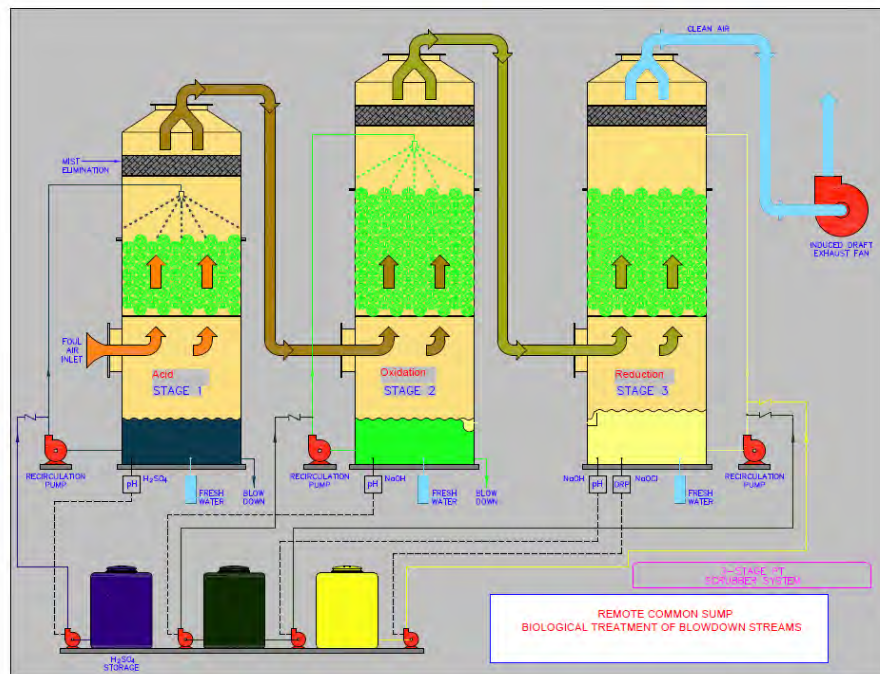

Figure 3-2. HEE/Duall's Proposed Three Stage Wet Scrubbing System

3.2.1 Technical Feasibility

HEE/Duall's proposed technology solution with the three-stage scrubbing system followed by carbon adsorption addresses all the targeted Hanford COPC groups. The HEE/Duall system should attain a total removal efficiency of 90% or greater for all Hanford targeted COPC groups since the downstream carbon adsorption systems can achieve high removal efficiencies (i.e., 99%). Table 3-4 includes vendor-provided removal efficiencies for these targeted groups. The vendor recommends pilot testing to verify removal efficiencies.

Table 3-4. HEE/Duall Projected Removal Efficiencies of Hanford Tank Farms Targeted COPC Groups

Technology Stage	VOCs	Dioxins/ Furans	NO _x	Ammonia	Mercury
Absorption					
1 st Stage: Acid Gas Spray Scrubber (Amines, Ammonia, Soluble Hg species)	99.5% (amines)			99.5%	95%
2 st Stage: Oxidation Spray Scrubber (Furans, NO, N ₂ O)		90% Furans	90% (NO, N ₂ O)		
3 rd Stage: Reduction Spray Scrubber (NO ₂)			99.5% (NO ₂)		
Adsorption					
Granular Activated Carbon (VOCs, Organic Hg)	99% ⁽¹⁾	99% ⁽¹⁾			
Sulfur Impregnated Carbon					99%
Total					
Absorption and Adsorption	99% ⁽¹⁾	99% ⁽¹⁾	90% ⁽²⁾ NO _x to N ₂	99.5%	99%

(1) Vendor provided efficiencies (see Sections 3.1.1 and 3.9.1)

(2) Second Stage Scrubber is limiting stage for conversion of NO/N₂O to NO₂ which gets converted to N₂ in 3rd Stage

3.2.2 Design Features

The design requires provisions for handling and disposal of the liquid effluents. Liquid handling may require treatment infrastructure or provisions for containment and transfer (e.g., in trucks). Ultimate liquid disposal may be as a solidified waste either locally or via a commercial vendor. Table 3-5 lists distinguishing design features of the proposed approach.

Table 3-5. Design Features of HEE/Duall Wet Scrubber and Carbon Bed Technologies

Design Features	Comments
Infrastructure Requirements⁽¹⁾	
Footprint of System	TBD
Utilities	Water, electrical
Passively Ventilated Tanks	Integration required of single-shell tanks in tank farm
Operating Parameters	
Scrubber System⁽¹⁾	
Air Flows	Acceptable flows > 500 scfm
Inlet Temperature	Recommended 40°F to 100°F
Pressure Drop	Low pressure drop for spray scrubbers
Pollutant Loading	Particulate loadings not critical in spray scrubbers operation
Carbon Beds⁽¹⁾	
Relative Humidity	Relative Humidity: < 50%
Air Flows:	System to be designed to achieve linear bed velocities (8-100 fpm)
Temperature	Recommended < 100°F (Higher temperatures can reduce adsorption capacities.)
Pressure Drops	TBD based on carbon bed design.
Additional Equipment Required	
Exhaust Fans	Eliminates fugitive emissions and draws gases through system May require fans between aqueous absorption and carbon adsorption units

Table 3-5. Design Features of HEE/Duall Wet Scrubber and Carbon Bed Technologies

Design Features	Comments
Mist Eliminator	Removes entrained liquid prior to entering carbon beds
Reheater	Reduces relative humidity to 50% or below.

⁽¹⁾ Typical as vendor did not provide. (U.S. EPA, March 2006) (U.S. EPA, CTC, May 1995)

3.2.3 Operational Considerations

Table 3-6 discusses the maintenance and monitoring requirements for the proposed approach.

The vendor claim of no monitoring for this application is suspect. Monitoring for operational performance, chemical consumption, and emissions compliance is likely needed.

Table 3-6. Operational Considerations of HEE/Duall Wet Scrubber and Carbon Bed Technologies

Operational Considerations	Comments
Monitoring Requirements ⁽¹⁾	Continuous operational monitoring is not required.
	Remote control panel included in design for monitoring.
Maintenance Requirements ⁽¹⁾	Low maintenance is anticipated with system minimal moving parts.
	Non-routine cleanout of salts from scrubber system will be required.
	Non-routine sampling of carbon (to determine organic loading)
Consumables	Chemicals for three-stage scrubbing system: sodium hypochlorite, sulfuric acid, and sodium hydrosulfide (Volume will be determined based upon pilot testing.)
	GAC and sulfur impregnated carbon and carbon containers

⁽¹⁾ Typical as vendor did not provide.

3.2.4 Secondary Waste

Secondary waste includes both scrubbing liquids and used carbon. Scrubbing liquid waste will contain ammonium sulfate salts, maleic anhydride, acetic and oxalic acids, as well as soluble mercury compounds. The liquid secondary liquor requires review to assess whether it is a hazardous waste. Used carbon will contain adsorbed VOCs and Hg compounds and may require disposal within a hazardous waste landfill.

The generation rate for both liquids and used carbons depends on the inlet concentrations of contaminants. HEE/Duall provided rough estimates of scrubbing wastewater generation of 0.5 gpm per scrubber. This rate equates to 12 standard 5,500 gal tanker trucks per month, or roughly three per week.

By placing the carbon beds after the wet scrubbers, HEE/Duall reduces the generation rate of used carbon. Pilot testing is required to provide data to validate the scrubbing liquid and spent carbon generation rates.

The secondary waste generated by this treatment strategy creates the need for wastewater treatment and solid waste disposal. During discussions at the workshop, HEE/Duall indicated a variant of the proposal could include a bio-degradation system to eliminate the need for solidifying the wastewater with subsequent disposal. However, such an approach would require laboratory testing to assess feasibility for the contaminants in this application.

3.2.5 Safety/Regulatory

Both absorption and adsorption are mature technologies, and therefore, potential safety issues are readily identifiable based upon historical information. The vendor will be required to conduct a hazard analysis and provide recommended safety systems and interlocks in the design phase, if warranted. There are no known nuclear safety issues.

Safety considerations for the proposed absorption scrubbing system include operations involved in handling of the proposed scrubbing liquids: sulfuric acid, sodium hypochlorite, and sodium hydrosulfide.

The safety considerations for the carbon sorption unit are identical to those previously discussed – see Section 2.2.5.

The regulatory assessment for the wet scrubbing system needs to evaluate the additional chemicals (sulfuric acid, sodium hypochlorite, and sodium hydrosulfide) added to the Hanford Tank Farm chemical inventory. In addition, the assessment will need to determine the classification for the secondary waste stream from the liquid effluents. The aspects of permitting for the used carbon is identical to those previously discussed (see Section 2.2.5). Both streams may classify as hazardous wastes.

3.2.6 Cost/Schedule

The vendor did not provide a cost estimate.

HEE/Duall recommends a six-month pilot study to determine operation efficiency and operational/design parameters including: verify predicted removal efficiencies, confirm secondary waste volumes for scrubbing liquor, and determine carbon bed replacement frequencies.

3.2.7 Summary Rating

The HEE/Duall proposal integrates mature technology and addresses a robust range of the COPCs with estimated moderate to high removal efficiencies. However, scrubbing technologies are typically less effective in applications such as the Hanford Tank Farms due to the limitations of absorption processes discussed in Section 2.2.1. In addition, the carbon adsorption technologies enable the higher removal efficiencies. The system is of moderate capital cost with several scrubbing stages followed by carbon adsorption. The vendor anticipates relatively high generation rates of liquid wastewater needing confirmation by pilot testing. The scrubber removal efficiencies would also need confirmation through pilot testing since each scrubbing system (i.e., pollutant and absorbing solvent) is unique. Integration into multiple tank farms will require substantial investment in infrastructure. A final disposition path for the resulting liquids will add costs and require additional permitting. The technology is sufficiently mature to proceed to pilot demonstration if desired.

Table 3-7 provides a summary of the evaluation of the HEE/Duall proposed adsorption scrubbing system followed by “polishing” carbon beds using the evaluation criteria and metrics in the Introduction.

Table 3-7. Summary of HEE/Duall’s Wet Scrubber and Carbon Bed Technologies

Evaluation Criteria	Rating
<i>Technical Feasibility</i>	Yellow
<i>Design Features</i>	Yellow
<i>Operational Considerations</i>	Yellow
<i>Secondary Waste</i>	Red
<i>Safety/Regulatory</i>	Red
<i>Cost / Schedule</i>	Yellow

3.3 NESTEC

The NESTEC proposed system includes a regenerative thermal oxidizer (RTO) to destroy the organics with heat recovery, followed by a catalytic converter (e.g., selective catalytic reactor (SCR) system) that injects urea and a catalyst to generate ammonia for conversion on NO_x to nitrogen. The design provides a

quench and caustic scrubber (if needed for acid gas control) followed by carbon injection and baghouse for mercury control. In summary, the NESTEC proposed system consists of the following operations.

- Regenerative Thermal Oxidizer (RTO) to combust VOCs at 1500°F to 1800°F
- Selective Catalytic Reactor (SCR) for NO_x abatement
- (Optional) Gas Scrubber (NaOH) to neutralize acid gases and control water-soluble mercury compounds
- Carbon Injection/baghouse for additional mercury control

3.3.1 Technical Feasibility

NESTEC has successfully deployed thermal oxidizer systems providing data to demonstrate VOC DREs of > 99%. NESTEC claims the proposed system will remove all of the targeted Hanford Tank Farm COPC groups. Table 3-8 includes vendor-provided efficiencies for these targeted groups.

Table 3-8. NESTEC Projected Destruction Removal Efficiencies of Hanford Tank Farms Targeted COPC Groups

NESTEC's Proposed Technology Strategy	VOCs	Dioxins/ Furans	NO _x	Ammonia	Mercury
Thermal Oxidation					
Regenerative Thermal Oxidizer	> 99%	> 99%		99%	99% oxidizes organic Hg
Selective NOx Reduction					
Selective Catalytic Reactor			NP ⁽¹⁾		
Gas Scrubber (Optional)					
Spray Scrubber (5% NaOH)			99.5% (NO ₂)		NP ⁽¹⁾ Soluble mercury compounds
Carbon Adsorption					
Carbon Injection with Baghouse					NP ⁽¹⁾
Total					
Absorption and Adsorption	99%	99%	NP ⁽¹⁾	99%	NP ⁽¹⁾

⁽¹⁾ NP = not provided. Mercury removal efficiency data for carbon injection systems in Section 3.10.1 show that sulfur impregnated carbon have much higher removal capabilities.

3.3.2 Design Features

NESTEC will provide a turn-key, skid-mounted system that integrates all of the air pollution control technologies with the necessary controls, piping, and fabrication. The NESTEC design uses spray scrubbers, which are less sensitive to high dust loadings. Table 3-9 provides other design features.

Table 3-9. Design Features of the NESTEC Regenerative Thermal Oxidation System

Design Features	Comments
Infrastructure Requirements	
Footprint of System	3 skid with overall length near 40 ft
Utilities	Water; caustic; Electrical (480VAC, 3 phase; 110 VAC, 1 phase); compressed air
Fuel Requirements	Natural gas; Maximum amount – 5000 scfh natural gas per 2000 cfm process flow
Fresh water	Not provided
Passively Ventilated Tanks	Integration of the passively ventilated tanks in a tank farm required; Eliminates fugitive emissions
Operating Parameters	

Table 3-9. Design Features of the NESTEC Regenerative Thermal Oxidation System

Design Features	Comments
<i>Thermal Units –RTO</i>	
Temperatures	RTO temp. 1500°F to 1800°F
Design Air Flows:	Maximum inlet: 2000 scfm
Residence time	2 seconds
<i>Selective Catalytic Reactor</i>	
Temperatures	Inlet: 450°F
<i>Spray Scrubber</i>	
Temperature	Maximum inlet: 160°F
<i>Additional Equipment Required (for Passively Ventilated Tank Farm)</i>	
Combustion Air Fan	Details not provided
Exhaust Fans	2300 cfm; 10 hp, 11.6 amp, 7.5 kW
Water Circulation Pump	Details not provided
Quench	Cools to 160°F
Baghouse	Removal of Carbon Injection Powder; Design TBD

3.3.3 Operational Considerations

Table 3-10 provides operational considerations.

Table 3-10. Operational Considerations for the NESTEC Regenerative Thermal Oxidation System

Operational Considerations	Comments
<i>Monitoring Requirements</i>	<ul style="list-style-type: none"> - Daily Monitoring of 4-5 times because of multiple systems. - Control panel designed for remote monitoring; will monitor the composite LEL, temperature, and air flow. Composite LEL is monitored for safety and fuel usage.
<i>Maintenance Requirements</i>	<ul style="list-style-type: none"> - Monthly Service: shutdown to replace any failed instrumentation, change filters, etc. - Annual Maintenance: Inspection of burner nozzles, scrubber nozzles and quench chamber, set-point verification and interlocks. Replacement as required.
<i>Consumables</i>	<ul style="list-style-type: none"> - NaOH or NaBr neutralizing chemical for Scrubber - RTO natural gas fuel

NESTEC offers full maintenance support contracts for their deployments. (However, the potential for radioactive contamination may limit the extent and nature of any such contractual support.)

3.3.4 Secondary Waste

The NESTEC proposed abatement system generates scrubber wastewater containing sodium chloride salts as well as soluble mercury compounds, and carbon powder used for mercury removal. The secondary waste generation rate depends upon the inlet COPC concentrations. At normal average concentrations, the system will recirculate the scrubbing liquid and will only require “blowdown” when the salts reach a limit set to minimize accumulation and plugging in the system. NESTEC provided a very “rough” estimate for generation rate of scrubber wastewater of 0.5 gpm. The secondary waste generated by this abatement strategy adds the need for wastewater treatment and disposal and for disposal of used carbon powder with adsorbed mercury.

3.3.5 Safety/Regulatory

Section 2.4.5 provides safety considerations applicable to any deployment of thermal oxidizers in the Hanford Tank Farms. The NESTEC thermal oxidation systems include a control loop monitoring upstream composite lower explosive limit (LEL) with safety interlocks.

From a regulatory perspective, the NESTEC design requires assessment for treatment and disposal of the scrubbing wastewater and the mercury contaminated carbon powder. The use of urea in the SCR for the NO_x combustion adds a potential for “ammonia slip”, allowing potential emissions of as much as 50 ppm of ammonia (even with monitoring and control of added amounts of urea).

3.3.6 Costs/Schedule

Thermal oxidation systems include a comparatively high capital expense and the potentially high cost of energy to heat the incoming off-gas. NESTEC did not provide any specific costs as these would emerge in the engineering and design development stage of the project. They did provide historical information on the cost of similarly sized systems of 2000 scfm as approximately \$4 million. The design phase costs may range between \$80,000 and \$100,000.

NESTEC did not provide an estimated full duration of schedule to provide a treatment system. They estimate that the initial engineering and design phase will take 4 months. Fabrication occurs at a subcontractor; NESTEC has established relationships with three fabricating shops.

3.3.7 Summary Rating

The NESTEC proposal uses mature technology and addresses a robust range of the COPCs with estimated high removal efficiencies for VOCs but moderate removal efficiencies for Hg due to the use of a carbon injection system. The system is a high cost, complicated design with many moving parts and relatively high maintenance and operational requirements. Secondary waste generation will include both scrubbing wastewater and spent carbon powder that require treatment and disposal that increases the overall proposal cost. There are also nuclear safety issues to overcome. The technology is sufficiently mature to demonstrate at pilot scale without additional development or testing.

Table 3-11 provides a summary of the evaluation of the NESTEC regenerative thermal oxidation system using the evaluation criteria and metrics in the Introduction.

Table 3-11. Summary of NESTEC Regenerative Thermal Oxidation System Evaluation

Evaluation Criteria	Rating
<i>Technical Feasibility</i>	
<i>Design Features</i>	
<i>Operational Considerations</i>	
<i>Secondary Waste</i>	
<i>Safety/Regulatory</i>	
<i>Cost / Schedule</i>	

3.4 W. L. Gore & Associates

The Gore proposal included use of their filter bag modules (see Figure 3-3, (W. L. Gore & Associates, 2015)) for NO_x, ammonia, dioxins, furans, and mercury. As such, the proposal does not address treatment of VOCs and amines. The currently available data does not establish the removal efficiency for organo-mercury compounds since the industrial deployments to date focus on elemental mercury. Even so, the media will likely provide treatment for these species.

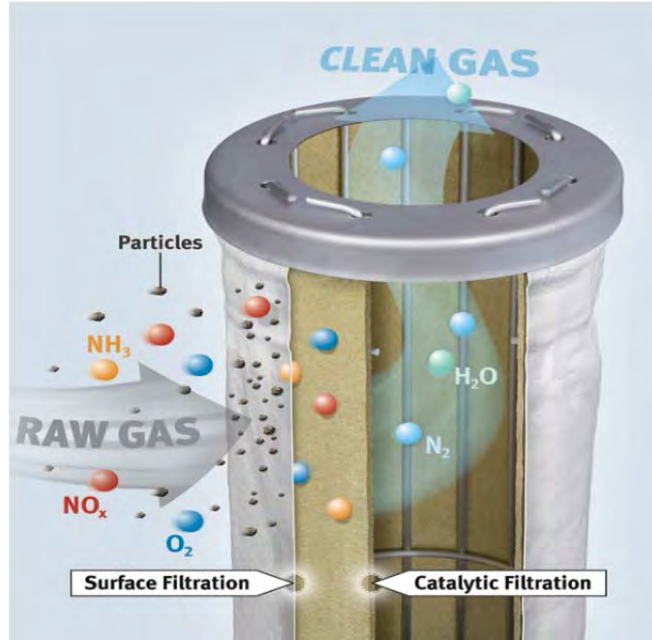

Figure 3-3 GORE[®] DeNOx Catalytic Filter Bags combine an outer layer filter bag for particulate removal with a catalyst insert for NO_x and NH₃ reduction

3.4.1 Technical Feasibility

Gore’s proposed technologies provide control of the following Hanford targeted COPC groups: NO_x, ammonia, dioxins, furans, and mercury. Table 3-12 provides projected removal efficiencies. The efficiencies depend upon design and configuration of their catalytic filter bags or chemical adsorption systems (i.e., number of units or modules used in system). The GORE[®] DeNOx filter bags for removal of NO_x and NH₃ may require ammonia injection depending on the stoichiometric concentrations in the ventilation gas stream.

Gore provides data showing the REMEDIA[®] filter bags yield outlet concentrations and dioxins and furans of 0.02 to 0.04 ng TEQ/Nm³ for a municipal waste combustor. (W. L. Gore & Associates, 2015) (W. L. Gore & Associates, 2016) In current deployments, GORE[®] DeNOx filter bags remove NO_x and NH₃ with typical final NO_x concentrations of <80 mg/Nm³ (dry basis), or 61 ppm_v, and NH₃ concentrations of less than <10mg/Nm³ (dry basis), or 13 ppm_v, assuming a stoichiometric balance of the ammonia and NO_x inlet concentrations. (W. L. Gore & Associates, 2016)

Gore personnel identified the following restrictions on concentration of specific species to ensure optimal operation: poison avoidance: SO₂ < 200 ppm (REMEDIA[®]) and < 5 ppm (DeNOx), as well as phosphorous < 500 ppm (for both technologies).

The GORE[®] Mercury Control System achieve outlet concentrations of <10 µg/Nm³ (dry basis).

Table 3-12. W.L. Gore’s Projected Removal Efficiencies of Hanford Tank Farms Targeted COPC Groups

W.L. Gore’s Proposed Technology Strategy	VOCs	Dioxins/ Furans	NO _x	Ammonia	Mercury
Catalytic Filtration					
REMEDIA [®] Modules		≥90% ⁽¹⁾			
GORE [®] DeNOx Modules			<80	≤10 mg/Nm ³	

Table 3-12. W.L. Gore’s Projected Removal Efficiencies of Hanford Tank Farms Targeted COPC Groups

W.L. Gore’s Proposed Technology Strategy	VOCs	Dioxins/ Furans	NO _x	Ammonia	Mercury
			mg/Nm ³		
Chemical Adsorption					
Mercury Control System	TBD				<10 µg/Nm ³
Total					
Catalytic Filtration / Chemical Adsorption	TBD	99% ⁽¹⁾	<80 mg/Nm ³	≤10 mg/Nm ³	<10 µg/Nm ³
⁽¹⁾ (W. L. Gore & Associates, 2016)					
<i>Note: Removal efficiencies are inversely dependent on face velocity at filter module</i>					

Since the filter fabrics contain fluoropolymers, they may exhibit an affinity for some of the VOCs identified in Hanford gas stream. However, Gore personnel indicate an absence of test or field data to establish a claim for trapping of these compounds. Similarly, these compounds may pose a risk of saturating the membranes and reducing the efficiency for treating the other species.

Catalytic destruction of dioxins and furans produces HCl acids that may require additional treatment depending on the concentrations. (W. L. Gore & Associates, 2016)

Gore provided evidence of numerous commercial applications of these media (>150 for REMEDIA[®], >16 for Mercury Control System, and 9 for GORE[®] DeNO_x). The team judges the technology as mature and viable for field demonstration within the Hanford Tank Farms after further examination of:

- the affinity for trapping VOCs, and
- an assessment of mercury removal efficiency relative to the media proposed by other vendors.

3.4.2 Design Features

The catalyst in the DeNO_x filter bags operates at a temperature of 356°F to 446°F. The catalyst in the REMEDIA[®] filter bags operates at a temperature of 350°F to 400°F and a face velocity of <3 fpm through the media.

The mercury control modules operate at temperatures below 200°F, relative humidity below 50% RH, and face velocity of 8 to 16 ft/s. Discussions with the vendor indicated a pressure drop of 0.25 in w.c. per module.

The filter bags are designed to be installed in a bag house. Gore personnel provided informational quality cost estimates for both 12 and 24 layer designs to treat flow rates of 2000 scfm

The design requires NO_x online monitoring and control system to control ammonia injection to ensure a stoichiometric balance of ammonia and NO_x for complete destruction.

Table 3-13 summarizes the design requirements for the Gore media.

Table 3-13 Design Features of W. L. Gore Mercury Control System

Design Features	Comments
Infrastructure Requirements	
Footprint of System	12 layer (48 modules): 8 ft X 26 ft X 32ft 8 in (height) 24 layer (96 modules): 8 ft X 26 ft X 32ft 8 in (height)

Table 3-13 Design Features of W. L. Gore Mercury Control System

Design Features	Comments
Utilities	Electrical for ventilation fans and heaters
Operating Parameters	
Thermal Units –Catalytic Filtration (REMEDIA® and DeNOx)	
Temperatures	DeNOx: 356°F to 446°F REMEDIA®: 350°F to 400°F
Design Air Flows:	2000 scfm (2.1 ft/s facial velocity)
Chemical Adsorption (Mercury Control System)	
Temperatures	Inlet: < 200°F
Relative Humidity	< 50%
Pressure drop	0.25 in w.c. per module
Additional Equipment Required	
Exhaust Fans	Required for System
Heater	Upstream of DeNOx and REMEDIA® Filter Bags

3.4.3 Operational Considerations

These filter modules are passive and require flow and pressure monitoring during operation. Periodic sampling of the exhaust would determine performance of the media. The DeNOx filter bags require periodic inspection for formation of ammonium salts. At end of life as determined by emissions monitoring, the filter modules require removal, disposal, and replacement. Table 3-14 summarizes the operational considerations.

Table 3-14. Operational Considerations for the W. L. Gore Catalytic Filtration and Chemi-Adsorption Technologies

Operational Considerations	Comments
Monitoring Requirements	Minimal monitoring (i.e., NO _x online monitoring control system for ammonia injection)
Maintenance Requirements	Replacement of failed bags (frequency TBD) Annual Maintenance: set-point and control loop verification
Consumables	<ul style="list-style-type: none"> - Ammonia for DeNOx system - REMEDIA® / DeNOx Filter Bags - Hg Control System Modules

3.4.4 Secondary Waste

The spent Mercury Control System filter modules are a hazardous waste. In verbal discussions, Gore personnel stated that the typical module when spent contains as much as 2.7 lb of mercury. The current EPA ruling for these modules from power plants deployments treats the modules as mercury contaminated debris allowing lined concrete landfill disposal.

The spent DeNOx and REMEDIA® media are non-hazardous waste.

Verbal discussions indicate Gore personnel lack data related to potential for trapping of radionuclides on the media.

3.4.5 Safety and Regulatory Considerations

These technologies are passive and the risks to personnel safety are minimal. These technologies do not introduce any new hazards in respect to nuclear safety. Environmental permitting will be required.

Use of ammonia for the GORE® DeNOx Modules for NO_x conversion adds a potential for “ammonia slip”, allowing potential emissions of ammonia (even with monitoring and control of added amounts of ammonia).

Disposal of spent Hg filter modules require toxic landfill disposal.

3.4.6 Cost and Schedule

W.L. Gore generated information-quality cost estimates (Total Equipment Cost, uninstalled) for Mercury Control Systems to treat a 2000 scfm flow: ~\$1.2 million for 12 layer / 48 module design and ~\$1.9 million for a 24 layer, 98 module design. A 2000 scfm system that incorporates DeNOx including preheaters with 180 filter bags costs roughly \$1.1 million.

The cost of catalytic bags (\$1,000 apiece for 6 inch diameter by 12 in length) or mercury modules (\$7,500 apiece) in an appropriately sized bag house would be considered moderate. The activated carbon modules are more expensive than other forms of activated carbon for mercury removal but the additional cost might be offset by higher loading before breakthrough. All three of these options require the fabrication of additional equipment to house and support. Fabrication of a bag house or similar structure would put the installation of such equipment 6 months to 1 year subsequent to contract issuance.

3.4.7 Summary Rating

The Gore proposal provides control of NO_x, ammonia, dioxins, and furans using a proprietary technology that combines both filtration and catalytic destruction that requires heating of the off-gas. Mercury removal occurs via a proprietary filter module and chemi-sorption. The system is a relatively high-cost (based upon the number of modules needed to meet removal efficiencies) but simple design with minimal moving parts and low maintenance requirements. The Gore Mercury Control System (GMCS) with mercury filters may provide advantages over the traditional carbon beds when considering simplicity in deployment and safety by eliminating the risk of bed fires. Technical unknowns for the GMCS include the extent of trapping and interference posed by volatile organics, as well as mercury removal efficiencies achievable based upon specific number of GMCS modules. SRNL proposes that its staff work with Gore personnel to obtain test data on the performance under conditions relevant to the Hanford application. The technology is sufficiently mature for pilot scale demonstration at Hanford.

Table 3-15 provides a summary of the evaluation of the Gore technologies using the evaluation criteria and metrics in the Introduction.

Table 3-15. Summary of W.L. Gore Technologies Evaluation

Evaluation Criteria	Rating
<i>Technical Feasibility</i>	
<i>Design Features</i>	
<i>Operational Considerations</i>	
<i>Secondary Waste</i>	
<i>Safety/Regulatory</i>	
<i>Cost / Schedule</i>	

3.5 Schenck Process Group

Schenk Process Group (with plasma technology competence center in Norway) proposed use of a non-thermal (corona discharge) plasma unit as the primary technology for treating the Hanford Tank Farms

off-gas. Their system directs flow through an electrostatic precipitator to oxidize the contaminants. They are developing a high-density corona discharge plasma generator more suitable for treatment of NO_x off-gas and, hence, to the difficult multi-component gas in the tank farm. They did not provide a full conceptual system but indicated possible need to couple the plasma with other technologies such as UV treatments, wet scrubber absorption, or final carbon sorption for the application.

3.5.1 Technical Feasibility

Schenck personnel provided a qualitative assessment of expected treatment efficiencies for the Hanford COPCs (see Table 3-16). Schenck personnel indicated the typical deployment treats off-gas containing <100 mg/m³.

Table 3-16. Destruction probability for Hanford Off-gas Constituents by Non-Thermal Plasma

FUNCTIONAL GROUP	DESTRUCTION PROBABILITY
Nitrates	Likely to be destroyed
Amines	Likely to be destroyed
Nitrous Oxide	No destruction expected
Ammonia	Some reduction expected
Pyridines	Likely to be destroyed
Phosphates	Likely to be destroyed
Nitriles	No significant destruction expected
Mercury	Greater than 80% removal
Furans	Likely to be destroyed
Aromatics	Likely to be destroyed

The plasma may form NO_x, formaldehyde, and acetaldehyde from some compounds in the Hanford COPC list. Ammonia may form salts depending on the concentration of acids in the gas yielding deposits inside the equipment.

The vendor provided data from an industrial pilot deployment of the two stages of plasma treatment coupled with downstream carbon sorption. Data from only the plasma unit operation showed high DREs (i.e., near complete removal) for ethylbenzene and styrene compounds but relatively little effectiveness for toluene (50% reduction) or benzene (20% reduction).

By itself, this implementation of non-thermal plasma will not achieve destruction efficiencies sufficient to reach the goal of 10% of OEL for any of the chemicals of concern.

Schenck is developing a high-density plasma version of the technology for ammonia treatment but this design is currently limited to developmental testing. This technology increases the ozone formation roughly an order of magnitude, yielding associated improvements in DREs. The configuration in development has the following sequential unit operations: electrostatic precipitator, cooling, high-density plasma, ultraviolet section for aerosol formation, an electrostatics precipitator (either dry or wet scrubber variety), and an ozone destruction section. The vendor has approximately 7 years of laboratory development but no commercial deployments at this time.

3.5.2 Design Features

The footprint for the system proposed is 41 ft² and 17.5 ft tall. The unit requires 30 kW electrical power. Ambient temperature is assumed for the gas inlet. The system proposed by Schenck Process would treat flows up to 12,000 scfm.

3.5.3 Operational Considerations

The design assumes monitoring for alarms, either locally or remotely. Remote monitoring necessitates regular operator rounds to assess physical condition and local indicators, nominally daily.

Schenck reported that their systems require weekly inspection of the reaction chamber and replacement of broken or damaged electrodes. Schenck uses a coaxial configuration in their reaction chamber. Other configurations may not be as susceptible to damage in normal operation but the concern is prevalent enough that it should be considered in any plasma generator.

Particulates may be generated in the reaction chamber depending on the gas components and conditions. The equipment requires periodic inspection and cleaning to remove deposits.

3.5.4 Secondary Waste

Some compounds may create secondary waste such as NO_x, formaldehyde, and acetaldehyde. Ammonia may form salts depending on the concentration of acids in the gas. Ultraviolet systems may create additional NO_x.

3.5.5 Safety and Regulatory Considerations

Tuning the voltage for the electrodes mitigates the formation of deposits. The vendor provides assistance with tuning remotely from their competence center in Norway. Avoiding deposits helps mitigate risk of localized particulate fires on the electrodes.

The NO_x generation and ultimate emissions require assessment for permitting concerns.

3.5.6 Cost and Schedule

Schenck did not provide cost estimates for a system nor estimated schedule duration.

3.5.7 Summary

The Schenck Process proposal uses a technology successfully deployed in the European food and pharmaceutical industry. The Hanford tank farm environment is challenging for this technology due to the more diverse mixture of compounds and the presence of compounds known to be difficult to treat with this technology. Existing data does not allow estimation of destruction and removal efficiencies without testing representative samples. The system has potentially high maintenance costs associated with the inspection and replacement of electrode wires. This proposed design requires significant development prior to entering a pilot testing phase. Table 3-17 provides a summary of the evaluation of Schenck Process's proposed non-thermal plasma system using the evaluation criteria and metrics in the Introduction.

Table 3-17. Summary of Schenck Process's Non-Thermal Plasma System Evaluation

Evaluation Criteria	Rating
<i>Technical Feasibility</i>	
<i>Design Features</i>	
<i>Operational Considerations</i>	
<i>Secondary Waste</i>	
<i>Safety/Regulatory</i>	
<i>Cost / Schedule</i>	

3.6 ALZETA/Anguill

The ALZETA/Anguill proposal for abatement of the Hanford Tank Farm vapors combines thermal oxidation with downstream scrubbing to remove acid gases and soluble compounds of mercury. The proposed system consists of the following stages:

- Flameless Thermal Oxidizer to combust VOCs at 2300°F to 2500°F, and
- Gas Scrubber (using sodium hydroxide) to neutralize acid gases and remove water soluble mercury compounds.

ALZETA/Anguill proposes to utilize a Flameless Thermal Oxidizer (FTO), with tradename EDGE QR™, equipped with a Duratherm™ fibrous ceramic burner that provides radiant heat and no visible flame to yield ultra-high (>99.99%) destruction removal efficiencies for VOCs. This design mixes the tank vapors with fuel-heated air before drawing the mixture through the ceramic burner and into the exhaust. Combustion occurs on the inside of the burner cylinder, such that the ceramic burner layer provides uniform heat release over the entire surface. The surface reaction temperatures exceed 2000°F resulting in complete combustion with low NO_x generation. High excess air (typically 60 to 100% stoichiometric excess) maximizes the combustion efficiency. Exhaust options include a rapid quench to 180°F and a packed bed counter-current scrubber for acid gas and removal of elemental and oxidized mercury before exiting the stack. The integral quench design includes multiple spray nozzles to minimize water use while rapidly reducing the gas temperature to minimize formation of dioxins and furans. Figure 3-4 shows the EDGE QR™ oxidizer.

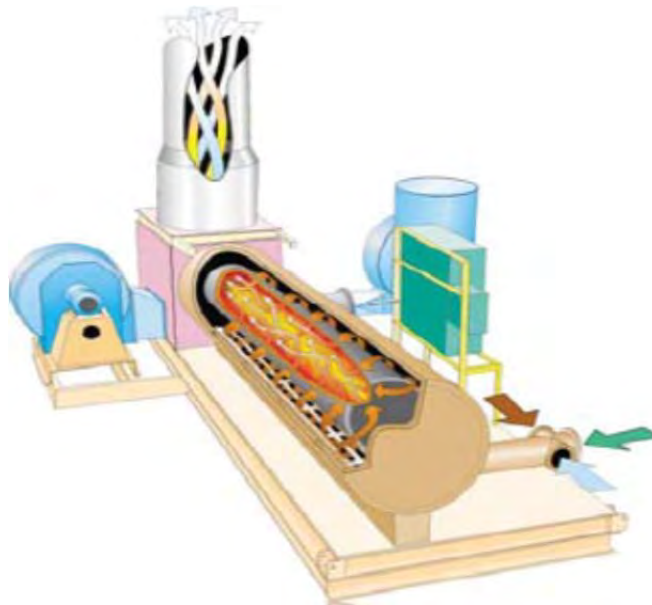

Figure 3-4. The ALZETA Flameless Thermal Oxidizer EDGE QR™ System

3.6.1 *Technical Feasibility*

ALZETA has deployed thermal oxidizer systems on similar applications as the Hanford Tank Farm ventilation system containing relatively low VOC concentrations with low total gas flow. Applications include Superfund projects (including one at the Lowry Landfill, for Parsons Corporation) involving soil vapor extractions. ALZETA/Anguill provided documentation showing destruction removal efficiencies (DREs) of 99.99% for compounds including: 2-Butanone, chlorobenzene, and dichlorodifluoroethane.

(Bartz, May 1996) The vendor has successfully taken measurements for removal efficiencies at outlet concentrations as low as 1 ppb.

ALZETA/Anguill anticipates the system will treat all targeted Hanford Tank Farm COPC groups with the exception of NO_x. While the burner design minimizes NO_x generation, oxidation of the nitrogen-bound COPCs such as ammonia and amines will generate NO_x. Approximately, 50-70% of the nitrogen in such compounds will form NO_x, with the balance converted to N₂. Therefore, the design should include downstream NO_x removal technologies.

The vendor indicated that the fate of mercury compounds inside the oxidizer merits consideration. The vendor literature indicates that mercury vapor will form HgO above 570°F and decompose to Hg and O₂ above 930°F. It remains unknown whether mercury will wet the fibrous ceramic and shorten the operating life. The proposal assumes no impact from the mercury and includes a scrubber to remove elemental and oxides of mercury from the exhaust. Efficiency of mercury removal needs confirming with pilot testing proposed for confirmation. Another option includes removal of mercury prior to the oxidizer. ALZETA/Anguill representatives suggested the W.L. Gore & Associates mercury membranes may perform ideally for this function.

Table 3-18 includes vendor-provided efficiencies for the targeted COPC groups.

Table 3-18. ALZETA/Anguill Projected Destruction Removal Efficiencies of Hanford Tank Farms Targeted COPC Groups

ALZETA/Anguill's Proposed Technology Strategy	VOCs	Dioxins/ Furans	NOx	Ammonia	Mercury
Thermal Oxidation					
FTO EDGE QR™ unit	99.99%	99.99%		99.99%	Oxidizes organic
Gas Scrubber					
Packed-bed Counter Current (NaOH)					NP ⁽¹⁾ (water soluble Hg compounds)
Total					
Thermal Oxidation and Absorption	99.99%	99.99%		99.99%	

⁽¹⁾ Not provided

3.6.2 Design Features

ALZETA propose a thermal oxidizer that reaches temperatures of over 2300°F to ensure DREs of 99.99%. ALZETA is employing packed bed scrubbers, which can be sensitive to high dust loadings. However, the use of HEPA filters in advance of the scrubbers should mitigate the risk of particulates. Table 3-19 lists other design features.

Table 3-19. Design Features of the ALZETA/Anguill Flameless Thermal Oxidation System

Design Features	Comments
Infrastructure Requirements	
Footprint of System	Vendor estimated: 8 ft. x 30 ft. for 1,000 scfm with scrubber
Utilities	Water; Electrical 480v 3 phase (See requirements for additional equipment)
Fuel Requirements	Natural gas or propane; Maximum amount – 3000 scfh natural gas per 1000 cfm process flow (3 MMbtu/h)
Fresh water	60 psi, 25 gpm, < 3 ppm of calcium
Instrument Air	100 psi, -40°F dewpoint, 15 scfm

Table 3-19. Design Features of the ALZETA/Anguil Flameless Thermal Oxidation System

Design Features	Comments
Passively Ventilated Tanks	Integration of ventilation system of single-shell tanks in tank farm
Operating Parameters	
Thermal Units	
Temperatures	FTO reaction: 2300°F to 2500°F
Air Flows:	Maximum inlet: 2000 scfm
Packed-Bed Counter Current Scrubber	
Temperature	Maximum inlet: 180°F
Additional Equipment Required (for Passively Ventilated Tank Farm)	
Combustion Air Fan	1000 cfm; 5 hp, 6.5 amp 3.8 kW
Exhaust Fans	2200 cfm; 10 hp, 11.6 amp, 7.5 kW
Water Circulation Pump	70 gpm, 7.5 hp, 9.2 amp, 6 KW
Quench	Cools to 180°F

3.6.3 Operational Considerations

Table 3-20 lists the vendor identified maintenance needs.

Table 3-20. Operational Considerations for the ALZETA/Anguil Flameless Thermal Oxidation System

Operational Considerations	Comments
Monitoring Requirements	<ul style="list-style-type: none"> - Daily Safety Walk (to verify normal operation) - Weekly Operating Log to record gauge readings, flowrates, etc. - Control panel designed for remote monitoring
Maintenance Requirements	<ul style="list-style-type: none"> - Monthly Service: Brief shutdown to replace any failed instrumentation, change filters, etc. - Annual Maintenance: Oxidizer may need replacement, Inspection of scrubber packing and quench chamber, set-point verification and interlocks.
Consumables	<ul style="list-style-type: none"> - NaOH neutralizing chemical - FTO fuel

3.6.4 Secondary Waste

The ALZETA/Anguil system will generate scrubber wastewater with sodium chloride salts and mercury. The secondary waste generation rate depends on the inlet COPC concentrations. The system will recirculate the scrubbing liquid and will only require “blowdown” when the salts reach a limit set to minimize accumulation and plugging in the system. ALZETA can estimate the generation rate of scrubber wastewater once provided the range of inlet concentrations for chlorinated hydrocarbons.

3.6.5 Safety/Regulatory

The oxidizer requires fuel delivery systems and fuel quantities in excess of current tank farm permitted limits (i.e., 5 gallon containers) and in close proximity to the tanks.

The ALZETA thermal oxidation system includes safety control loop monitoring for upstream composite lower explosive limit (LEL) with safety interlocks. A feature of the RTO inward-fired Duratherm™ burner is its inherent safety, especially in regards to flashback. The safety assessment needs to review this approach and decide on acceptability.

The oxidation process can result in treated vapor streams that contain undesirable byproducts that can including NO_x and sulfur oxides. The Edge QR™ unit uses an integral quench chamber immediately downstream of the oxidizer discharge rapidly cooling the gases to 180° F, minimizing dioxin/furan reformation. The regulatory assessment needs to consider possible residual concentrations of these compounds.

3.6.6 Cost/Schedule

Thermal oxidation includes a comparatively high capital expense and the potentially high cost of energy to heat the incoming off-gas. ALZETA/Anguil did not provide detailed cost estimate for this application as the engineering and design phase would yield that estimate. They provided historical information on the cost of a similarly sized system (for 1000 scfm) used at a Superfund site as approximately \$500,000 with scrubber blowdown released to the sewer. (A laboratory test unit for 200 slpm cost between \$100,000 to \$125,000 with a footprint of 24 in X 19 in X 6 ft.)

Schedule will be developed based upon the vendor recommended path forward. ALZETA indicated that supply of the Edge QR system would involve the following phases. ALZETA representatives suggested a deployment approach that includes a site demonstration to provide a performance evaluation (DRE) and mercury oxide deposition on the burner element. Full size design and fabrication would follow. ALZETA noted that the deployment for the Superfund sites elected to not perform pilots and directly proceeded to design.

3.6.7 Summary Rating

The ALZETA/Anguil proposal uses mature technology and addresses all the targeted Hanford Tank Farm COPC groups with the exception of NO_x. The ALZETA Flameless Thermal Oxidizer (FTO), EDGE QR™, has better VOC destruction removal efficiencies (>99.99 DRE) than other incinerators because of the high operating temperatures and the high excess air. However, the proposal may provide lower removal efficiencies for non-organic mercury species (removed via absorption vs carbon adsorption). The EDGE QR™ system is a high cost system, though relatively lower than other oxidizer systems. The EDGE QR™ is a modular unit, relatively compact, skid-mounted system and therefore, less complicated than other thermal oxidizers. The design will have maintenance and operational requirements typical of all thermal oxidizers. The proposal generates one liquid secondary waste stream requiring disposition. The design has the same fuel safety issues for nuclear safety as other proposals. The authors deem the proposed thermal unit as impressive based on its demonstrated performance of ultra-high VOC destruction as compared to other thermal oxidizers. However, the system, as proposed, is incomplete for the Hanford application without NO_x abatement and without demonstrated removal efficiencies for non-organic mercury species. The design is sufficiently mature for pilot scale implementation.

Table 3-21 provides a summary of the evaluation of the ALZETA/Anguil proposed carbon adsorption system using the evaluation criteria and metrics in the Introduction.

Table 3-21. Summary of ALZETA/Anguil Thermal Oxidation System Evaluation

Evaluation Criteria	Rating
<i>Technical Feasibility</i>	Yellow
<i>Design Features</i>	Yellow
<i>Operational Considerations</i>	Yellow
<i>Secondary Waste</i>	Yellow
<i>Safety/Regulatory</i>	Red
<i>Cost / Schedule</i>	Yellow

3.7 John Zink Hamworthy Combustion

John Zink’s proposed solution consists of a thermal oxidizer for VOC combustion at 2200°F. The proposed system includes a vertical thermal oxidizer with no heat recovery to destroy the organics resulting in higher operating costs for fuel. The high desired removal efficiencies targeted for some of the COPCs, of up to 99.99%, precluded their recommendation of a thermal unit with heat recovery, such as a regenerative thermal oxidizer, which has lower operating fuel costs but also lower removal efficiencies of 99%. John Zink did not include any additional control technologies for COPC abatement in their proposal. John Zink did not recommend any control technologies for mercury removal.

3.7.1 *Technical Feasibility*

John Zink has successfully designed and deployed over 3,000 thermal oxidizers worldwide, with a percentage of those on similar applications as the Hanford Tank Farm ventilation system (i.e., relatively low VOC concentrations and low flows). The proposed thermal oxidation unit provides high combustion temperatures of 2200°F yielding VOC destruction removal efficiencies of 99.999%. John Zink will provide a written guarantee to meet the VOC destruction targets. The vendor has a test facility in Tulsa, OK, in which numerous tests have proven the performance to meet the required efficiencies.

The proposed design removes all of the targeted Hanford Tank Farm COPCs with the exception of mercury and NO_x. The John Zink Low NO_x Y-Burner design minimizes NO_x generation. The vendor guarantees the performance of the Y-Burner to meet a maximum NO_x emission limit of 0.1 lb/million Btu. Note that this contribution to does not include any initial NO_x compounds in the off-gas nor compounds formed from nitrogen bearing constituents; it simply reflects the amount formed from fuel consumption. Table 3-22 includes both vendor-provided and literature removal efficiencies for these targeted COPC groups.

Table 3-22. John Zink’s Thermal Oxidation System Projected Destruction Removal Efficiencies of Hanford Tank Farms Targeted COPC Groups

John Zink’s Proposed Technology Strategy	VOCs	Dioxins/ Furans	NO _x	Ammonia	Mercury
<i>Thermal Oxidation</i>					
Thermal Oxidizer with Y-Burner	> 99.99%	> 99.99%		99.99%	
<i>Total</i>					
Thermal Oxidation	> 99.99%	> 99.99%		99.99%	

3.7.2 *Design Features*

John Zink will provide a turnkey, skid-mounted system that integrates a vertical thermal oxidation unit and the necessary controls, piping, and fabrication. Table 3-23 lists the design features provided by the vendor.

Table 3-23. Design Features of the John Zink Thermal Oxidation System

Design Features	Comments
<i>Infrastructure Requirements</i>	
System Footprint	Not provided
Utilities	Water; Instrument Air; 3 phase power for blower/control
Fuel	Natural gas flow: 281.3 lb/h
Passively Ventilated Tanks	Integration of passive tanks ventilation system in tank farm
<i>Operating Parameters</i>	
<i>Thermal Units –RTO</i>	
Design Temperatures	2200 °F
Design Air Flows	2000 scfm

Table 3-23. Design Features of the John Zink Thermal Oxidation System

Design Features	Comments
Additional Equipment Required	
Combustion Air Fan	
Stack	includes vertical chamber with stack
Panel Control System	Allen Bradley SIL-2 BMS

3.7.3 Operational Considerations

Table 3-24 provides operational considerations identified by the vendor.

Table 3-24. Operational Considerations for the John Zink Thermal Oxidation System

Operational Considerations	Comments
Monitoring Requirements⁽¹⁾	<ul style="list-style-type: none"> - Daily Monitoring - Control panel designed for remote monitoring; will monitor composite LEL, temperature, and air flow. Composite LEL is monitored for safety and fuel usage.
Maintenance Requirements⁽¹⁾	<ul style="list-style-type: none"> - Monthly Service: Brief shutdown to replace any failed instrumentation, change filters, etc. - Annual Maintenance: Inspection of burner nozzles, set-point verification and interlocks. Replacement as required.
Consumables⁽¹⁾	<ul style="list-style-type: none"> - Oxidizer natural gas fuel

⁽¹⁾ Typical for Thermal Oxidizers

3.7.4 Secondary Waste

The proposed system will not generate secondary waste. A design variant to consider is use of a carbon unit downstream for mercury adsorption, producing a low volume of secondary as mercury contaminated carbon.

3.7.5 Safety/Regulatory

The safety and regulatory considerations are those identified in the literature discussion for thermal oxidizers – see Section 2.4.5. The proposal does not address the fate of mercury implying the air permitting will need to assume presence of the bulk of this constituent.

3.7.6 Costs/Schedule

Limitations of thermal oxidation systems include its comparatively high capital expense and the potentially high cost of energy to heat the incoming off-gas. John Zink provided a budgetary proposal of \$500,000 for the thermal unit and support system only. The estimate is for planning processes and does not constitute a commitment by John Zink.

The vendor did not provide a conceptual schedule.

3.7.7 Summary Rating

The John Zink proposal uses mature control technologies and addresses all the targeted Hanford Tank Farm COPC groups with the exception of non-organic species of mercury. The thermal oxidizer with the Y-Burner has a guarantee from the vendor to meet higher VOC destruction removal efficiencies (>99.99% DRE). The Zink proposed unit operates at higher operating temperatures similar to the ALZETA EDGE QR™ unit. The Zink TO is a high cost system when compared to other non-thermal control technologies, though like the ALZETA EDGE QR™ system, on the lower range for thermal

oxidizer systems. The Zink TO, also like the EDGE QR™, is modular, relatively compact, skid-mounted system and, therefore, perceived to have a more simplistic design than other thermal oxidizers. The equipment will have the high maintenance and operational requirements typical of all thermal oxidizers. The proposed approach does not generate solid or liquid secondary waste streams requiring disposition. However, there are nuclear safety issues to overcome. The authors deem the proposed thermal unit as impressive, based on its demonstrated performance of ultra-high VOC destruction removal efficiencies. However, the proposed system is incomplete without non-organic mercury abatement. The proposal is sufficiently mature to advance to pilot scale demonstration.

Table 3-25 provides a summary of the evaluation of the John Zink thermal oxidizer system using the evaluation criteria and metrics in the Introduction.

Table 3-25. Summary of the John Zink Thermal Oxidation System Evaluation

Evaluation Criteria	Rating
<i>Technical Feasibility</i>	Red
<i>Design Features</i>	Yellow
<i>Operational Considerations</i>	Red
<i>Secondary Waste</i>	Green
<i>Safety/Regulatory</i>	Red
<i>Cost / Schedule</i>	Yellow

3.8 Beltran

Beltran Technologies proposes use of wet electrostatic precipitators for the control of potential particulate and aerosols in the vapor stream from Hanford tank farms. This technology may find use in conjunction with other technologies. For instance, the electron beam flue gas treatment systems manufactured by Pavac Industries utilize an electrostatic precipitator to precipitate nitrogen compounds out of the exhaust treated by the electron beam, which is then sold as fertilizer, which is not an applicable option for Hanford.

3.8.1 *Technical Feasibility*

This technology does not treat the chemicals of primary concern directly but can precipitate aerosol or particulate by-products generated by other technologies. Analysis of treated off-gas from other technologies, in particular non-thermal destruction, may indicate a use for electrostatic precipitators. If the primary treatment technology forms aerosols, then design should consider application of electrostatic precipitators.

3.8.2 *Design Features*

The size of a unit depends on the off-gas flow rate treated and the particulate or aerosol concentration generated by upstream processes.

In addition to three phase electrical power, wet electrostatic precipitators require a source of water for removal of the collected particulate.

3.8.3 *Operational Considerations*

Wet electrostatic precipitators are relatively simple devices. Beltran Technologies provides automatic control via a PLC. The equipment requires monitoring of alarms that can occur remotely.

Collected particulates and aerosols accumulate in the precipitator scrubbing liquor and require periodic disposal. The volume of and frequency for liquid disposal depend on the amount of particulate and

aerosol collected, and hence on the concentrations of contaminants in the off-gas. The vendor did not provide estimates of the generation rate for blowdown liquid.

Operations include periodic inspection of the electrodes; otherwise, maintenance should be minimal.

3.8.4 Secondary Waste

Wet electrostatic precipitators generate a liquid waste stream with constituents that require evaluation for toxicity to determine appropriate disposal strategies.

3.8.5 Safety/Regulatory

The risks associated with this technology are well known and controls for hazard mitigation well defined and codified. The design of the two vitrification facilities at Hanford (as well as the Defense Waste Processing Facility at Savannah River Site) include safety analysis for such systems. The project may build upon and adapt those analyses as appropriate.

3.8.6 Cost/Schedule

Costs associated with electrostatic precipitation depend on the particulate, particulate concentration, and design flow rates. Therefore, the vendor needs additional process analysis before providing a cost estimate. Units are built to specification; therefore, delivery of equipment typically requires 6 months to 1 year from contract issuance.

3.8.7 Summary Rating

Beltran Technologies proposed a wet electrostatic precipitator for capture and disposal of sub-micron particulate or aerosols. This proposal does not directly abate any of the chemicals of concern; if another selected technology generates significant concentrations of particulate or aerosols, that process may integrate an electrostatic precipitator. (The majority of other vendors did not include this equipment in their proposals.) Table 3-26 provides a summary of the evaluation of the Beltran Technologies’ wet electrostatic precipitator system using the evaluation criteria and metrics in the Introduction.

Table 3-26. Summary of Beltran Technologies’ Wet Electrostatic Precipitator System Evaluation

Evaluation Criteria	Rating
<i>Technical Feasibility</i>	
<i>Design Features</i>	
<i>Operational Considerations</i>	
<i>Secondary Waste</i>	
<i>Safety/Regulatory</i>	
<i>Cost / Schedule</i>	

3.9 NUCON, International

The NUCON proposed abatement strategy for the Hanford Tank Farm Vapor COPCs consists of the following primary unit operations:

- (Optional) Carbon Adsorption “Guard” Bed for VOCs removal,
- MERSORB[®] Chemically Treated Carbon Bed for Hg removal,
- Internal Combustion Engine for destruction of VOCs,
- Catalytic Convertor for NOx abatement, and
- (Optional) Cooler and Carbon “Polishing” Adsorption Bed for VOCs removal.

The NUCON design includes gas conditioning upstream for removal of water droplets, reduction in relative humidity and particulate polishing using HEPA filters. The initial stages in the process include removal of mercury using NUCON’s chemically treated carbon (MERSORB®) with an optional carbon guard bed (of GAC) upstream. After mercury removal, the design oxidizes the COPC vapors in an internal combustion engine followed by a catalytic converter to reduce the NO_x emissions. The three-way catalytic converter will: reduce nitrogen oxides, oxidize carbon monoxide, and oxidize unburnt hydrocarbons to products of complete combustion (i.e., N₂, CO₂, and H₂O). The catalytic converter exhaust gases are at 600°F and the design allows for optional cooling. The proposal includes heat recovery from the treated off-gas through a heat exchanger used to pre-heat the incoming tank farm vapor stream thereby reducing the relative humidity. An advantage of the NUCON proposed abatement strategy is the mitigation of fugitive waste tank emissions as the engine provides a vacuum for the system. Figure 3-5 shows the NUCON proposed abatement system.

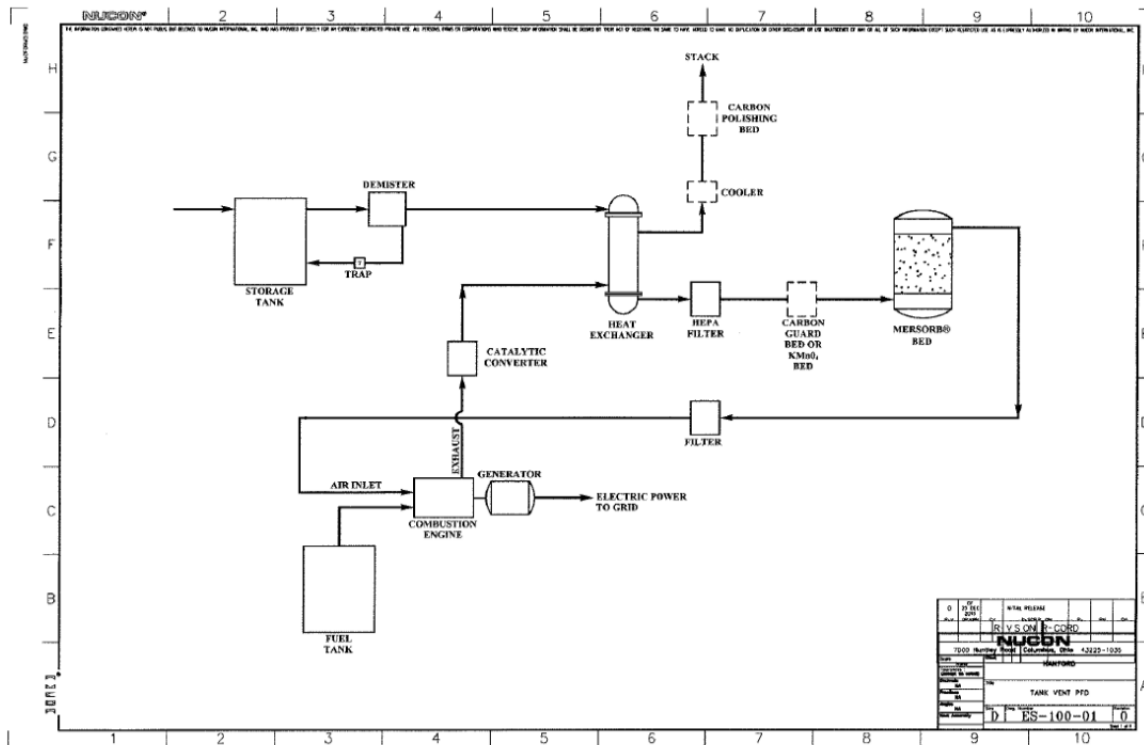

Figure 3-5. NUCON’s Proposed Abatement Strategy with Oxidation and Adsorption Technologies

3.9.1 Technical Feasibility

NUCON anticipates attaining DREs of 99% for VOCs with the combined thermal, catalytic and carbon systems. Table 3-27 provides the predicted removal efficiencies. The use of an internal combustion engine may offer lower residence time and lower temperatures than some thermal oxidizers proposed and hence NUCON is projecting lower destruction efficiency in that operation. The combustion engine is most effective at treating high concentration of VOCs in the off-gas (>3000 ppm). Off-gas with lower VOC concentrations (<1000 ppm) may require additional control technologies such as activated carbon technology shown as a downstream option in the NUCON proposal. Combustion engines can effectively achieve DREs between 90-98% for high concentrations of non-chlorinated VOCs. If the air-to-fuel ratio is not correct, the DRE drops accordingly. (U.S. EPA, March 2006) (Archabal, 1994)

Table 3-27. NUCON’s Projected Destruction Removal Efficiencies of Hanford Tank Farms Targeted COPC Groups

NUCON’s Proposed Technology Strategy	VOCs	Dioxins/ Furans	NO _x	Ammonia	Mercury
Carbon Adsorption					
GAC	95% to 98% ⁽¹⁾	95% to 98% ⁽¹⁾			
MERSORB [®]					99%
Thermal Oxidation / Catalytic Convertor					
Internal Combustion Engine	99%	99%		NP	
Catalytic Converter			NP	NP	
Total					
Thermal Oxidation, Catalytic Conversion, and Carbon Adsorption	99%	99%	NP	NP	99%

⁽¹⁾ Literature Source for inlet concentrations > 500 ppm (U.S. EPA, March 2006)

NP = not provided

The chemically treated carbon (i.e., sulfur-impregnated) preferentially removes elemental mercury. Any organic mercury (e.g., methyl mercury) not captured by the MERSORB[®] bed will disassociate in the engine and release elemental mercury, or and its oxides. The downstream equipment may not remove these residuals unless the final “polishing” carbon stage includes MERSORB[®].

Recommended inlet temperature range for MERSORB[®] adsorbents exceed those of other sulfur-impregnated carbons taking advantage of the fact that higher temperatures provide faster chemisorption kinetics. Competitive sulfur-impregnated Hg adsorbents advise that their Hg removal performance decreases with increasing temperature. The other commercial sorbents begin to lose sulfur at relatively low temperatures. MERSORB[®] mercury adsorbents are made by a different process and the quality control tests at 392°F (200°C), to ensure the material retains the sulfur at higher temperatures. Table 3-28 shows that removal efficiencies with MERSORB[®] under various test conditions were > 99% between 38°C and 150°C with less than one sec residence time. (NUCON, 2012)

Table 3-28 MERSORB[®] Removal Efficiencies from Various Applications

Application	Mixed Waste Incineration ¹	Mixed Waste Incineration ²	Hot Cell Vent SNS Facilities ³	Plasma- Enhanced Incineration ⁴
Gas	Inert Off-Gas	Inert Off-Gas	Air	Syngas
Mercury Conc., mg/m ³	10	16	0.055	0.55
Temperature, °C	150	107	38	30
Residence Time, s	0.99	0.63	0.7	20
Test Duration, h	1000	100	60	9
Mercury Removal Efficiency %	99.9	99.997	99.8	99.99

¹ (Del Debbio, 2003)

² (Boardman, February 2002)

³ (Broderick, 31 December 2002)

⁴ (Integrated Environmental Technologies, LLC, 8 June 2004)

NUCON plans to demonstrate their proposed system (7.5 ft x 10.0 ft) at their test facility using a flow rate of 30 scfm to verify estimated removal efficiencies, operating parameters, secondary waste generation, and carbon bed replacement frequencies. Final design, after feasibility testing, will target the range from 30 to 2000 scfm.

3.9.2 Design Features

NUCON plans to test a turn-key, skid-mounted system with the necessary controls, piping, and fabrication during the coming months. With successful piloting of the 30 scfm unit, follow on designs can begin for higher flows appropriate for the Hanford application. The design will incorporate data loggers to monitor and control system operating parameters including oil pressure and temperature, coolant temperature, exhaust temperature, O₂% in exhaust, flow rate, air-to-fuel ratio, and fuel input rates. Automatic adjustments to air-to-fuel input rate and fuel input rates will help maintain acceptable DREs. Table 3-29 lists design features identified by the vendor.

Table 3-29. Design Features of the NUCON Carbon Sorption and Internal Combustion Engine System

Design Features	Comments
Infrastructure Requirements	
Footprint of System	7.5 ft x 10 ft for 30 scfm
Utilities	Water; Power 110 V, 220 V; Air (Instruments)
Fuel Requirements	Propane or Natural Gas
Operating Parameters	
Internal Combustion Engine and Catalytic Converter	
Temperatures	600°F exhaust; inlet 57°F to 115°F
Design Air Flows:	Designed: 30 scfm (pilot)- 2000 scfm
Carbon Beds	
Temperature	MERSORB [®] inlet: 100°F to 302°F (38°C to 150°C) provides > 99% removal efficiencies; MERSORB [®] HT is for high temperature applications (> 150°C) (NUCON, 2012)
Humidity	Maximum inlet: < 50%
Additional Equipment Required	
Exhaust Fans	Not Required; engine draws vacuum
Air Cooling (Quench)	TBD if downstream carbon beds needed

3.9.3 Operational Considerations

Table 3-30 summarizes operational considerations provided by the vendor.

Table 3-30. Operational Considerations for the NUCON Carbon Sorption and Internal Combustion Engine System

Operational Considerations	Comments
Monitoring Requirements	Daily monitoring of 4-5 times because of multiple systems
Maintenance Requirements	<ul style="list-style-type: none"> Engines have limited warranties. Prior testing demonstrated 15,000 hour engine life with factory-recommended maintenance.⁽¹⁾ Routine maintenance is based on hours of engine operation; replacement of any failed instrumentation, etc. Battery and catalytic converter replacement every 5,000 - 10,000 hours of operation and inspection of burner nozzles, set-point verification and interlocks. Replacement as required.
Consumables	<ul style="list-style-type: none"> Fuel (natural gas or propane) Carbon bed adsorbents

⁽¹⁾ (U.S. EPA, March 2006)

3.9.4 Secondary Waste

The NUCON proposed abatement system generates used Hg adsorbent and used activated carbon adsorbent that require either toxic or mixed hazardous waste landfill disposal. The vendor did not estimate the secondary waste generation rate. The design yields minimal secondary waste if the carbon beds are downstream of the engine. If the carbon bed system is upstream of the engine, the secondary waste generation rate will resemble that of previously discussed abatement strategies using carbon adsorption as the primary treatment.

3.9.5 Safety/Regulatory

The safety and regulatory considerations are those identified in the literature discussion for thermal oxidizers (see Section 2.4.5), and for adsorption systems (see Section 2.2.5). Inclusion of the optional carbon sorption bed and the MERSORB[®] need assessed for the fire risk.

The regulatory and permitting needs to assess the fate of the mercury contaminated MERSORB[®] sorbent. (Precedence exists within DOE – for the application to the Neutron Spallation Facility at Oak Ridge National Laboratory.)

3.9.6 Cost/Schedule

NUCON did not provide a budgetary proposal. A noteworthy item is that NUCON is self-funding the feasibility testing and began procurement on equipment and materials. The cost of an internal combustion engine is significantly less than that of thermal oxidizers.

NUCON initiated design, fabrication, and testing of an integrated system (30 scfm) prior to the workshop. NUCON is willing to host visits and hold informal discussions on their test plans with Hanford project personnel (and with SRNL staff).

NUCON envisions the following tasks to demonstrate their recommended design:

- Design, fabricate, and assemble a 30 scfm unit,
- Perform pilot-scale testing to verify operation and validate instrumentation,
- Provide a complete report of pilot-scale studies,
- Transport the 30 scfm unit to Hanford site, if approved,
- Assist with installation of the 30 scfm unit on site-selected waste storage tank,
- Provide in-field verification of operation, and
- Provide in-field training to site personnel.

3.9.7 Summary Rating

The NUCON proposal employs mature control technologies and provides abatement for all targeted Hanford Tank Farm COPC groups. The internal combustion engine (ICE) and catalytic convertor coupled with carbon adsorption technologies provide 99% removal efficiencies of the following chemical groups: VOCs, all mercury species, ammonia, and the amines. The catalytic convertor provides NO_x abatement; however, the design requires pilot testing to determine the NO_x destruction efficiencies. The thermal unit is a relatively low-cost, simple system and is easy to replace at end of life. Secondary waste includes solid spent carbon containing mercury. Nuclear safety issues require addressing for fuel supply. The NUCON proposal is the simplest approach suggested use of a thermal oxidization process. NUCON is internally funding a pilot test. SRNL recommends providing direct technical consultation and monitoring of the test program (by SRNL staff members).

Table 3-31 provides a summary of the evaluation of the NUCON proposed system using the evaluation criteria and metrics in the Introduction.

Table 3-31. Summary of NUCON Thermal Oxidation and Carbon Bed System Evaluation

Evaluation Criteria	Rating
<i>Technical Feasibility</i>	Yellow
<i>Design Features</i>	Green
<i>Operational Considerations</i>	Green
<i>Secondary Waste</i>	Yellow
<i>Safety/Regulatory</i>	Red
<i>Cost / Schedule</i>	Green

3.10 Project Integration

Project Integration proposed treatment using two principal unit operations: thermal oxidation and carbon adsorption.

- Thermal Oxidation: A thermal oxidizer will oxidize organics, ammonia and nitrous oxides in a heated chamber at 1800°F.
- Carbon Adsorption: The design provides evaporative cooling of the exhaust from the thermal oxidation, potentially with dehumidification. Activated carbon and bicarbonate injection provides post oxidation treatment for residual organics, acid gases, and mercury removal from the air stream with particulate collection in a baghouse. The vendor stated, at the workshop, the design may also include sulfur impregnated carbon for mercury abatement.

The system includes an exhaust fan to pull the waste tank off-gas through the system while, mitigating risk of fugitive emissions. Figure 3-6 is a schematic depiction of the proposed system.

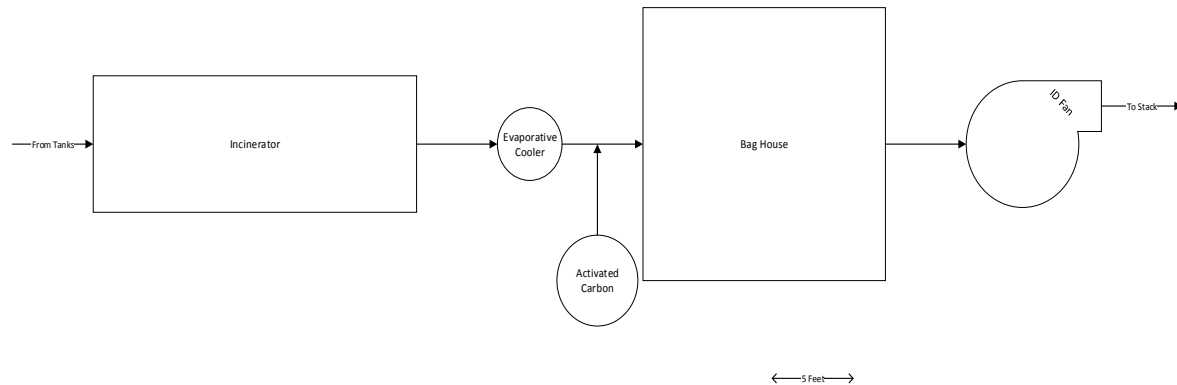

Figure 3-6. Project Integration’s Proposed Thermal Oxidation/Carbon Injection System

3.10.1 Technical Feasibility

The vendor provided an estimated efficiency of 99.99% DRE for VOCs. The thermal oxidizer would operate at 1800°F, with a 2 second residence time, and a Reynold’s Number >10,000 to meet the anticipated efficiencies. Project Integration did not provide removal efficiencies for mercury with the activated carbon powder injection system.

However, data is available from the National Energy Technology Laboratory, the Electric Power Research Institute and a group of utility companies demonstrating Hg removal efficiencies for several coal-fired electric utility applications using activated carbon injection (ACI) as shown in Table 3-32 (U.S. EPA-APPCD, February 2005). These applications were equipped with a cold or hot spray electrostatic precipitator while burning bituminous or subbituminous coals. In all cases, ACI improved mercury

capture over the baseline but did not attain the overall high removal efficiencies (>99%) projected by vendors of chemically treated activated carbon in carbon bed designs.

Table 3-32 Mercury Removal Efficiency for Combined Activated Carbon Injection and Baghouse

Test Site Information			Mercury Capture, %		
Test Site	Coal	Particulate Control	Baseline	ACI Test Results	Long-term Test Duration
PG&E NEG Brayton Point, Unit 1	Low-sulfur Bituminous	Two CS-ESPs in Series	90.8	94.5	ACI for two 5-day periods
PG&E NEG Salem Harbor, Unit 1	Low-sulfur Bituminous	CS-ESP	90	94	ACI for one 4-day period
Wisconsin Electric Pleasant Prairie, Unit 2	Subbituminous	CS-ESP	5	65	ACI for one 5-day period
Alabama Power Gaston, Unit 3	Low-sulfur Bituminous	HS-ESP COHPAC ⁽¹⁾	0	25-90	ACI for one 9-day period
University of Illinois Abbott Station	High-sulfur Bituminous	CS-ESP	0	73	

⁽¹⁾ Compact hybrid particulate collector (COHPAC)

The proposed system targets removal of all the targeted Hanford Tank Farm vapor COPCs except NO_x. Table 3-33 includes vendor-provided removal efficiencies for the targeted COPC groups.

Table 3-33. Project Integration Thermal Oxidation/ Activated Carbon Injection System Removal Efficiencies of Hanford Tank Farms Targeted COPC Groups

Project Integration's Proposed Abatement Technologies	VOCs	Dioxins/ Furans	NO _x	Ammonia	Mercury
Thermal Oxidation					
Thermal Oxidizer (1800°F)	99.99%	99.99%		99.99%	
Carbon Adsorption					
Activated Carbon Injection for Hg Removal					NP ⁽¹⁾
Total					
Thermal Oxidation and Adsorption	99.99%	99.99%		99.99%	NP ⁽¹⁾

Note: Organic mercury is disassociated in the oxidizer generating CO₂, H₂O, and Hg (elemental and oxide compounds)

⁽¹⁾ Not provided (NP) by vendor

3.10.2 Design Features

Project Integration proposes to provide a turn-key system that integrates a thermal oxidizer and carbon injection/baghouse system with the necessary controls, piping, and fabrication. The thermal unit would be a separate skid from the off-gas control equipment skid. Table 3-34 lists design features provided by the vendor.

Table 3-34. Design Features of Project Integration's Thermal Oxidation/Carbon Injection System

Design Features	Comments
Infrastructure Requirements	
System Footprint	75 ft x 20 ft

Table 3-34. Design Features of Project Integration’s Thermal Oxidation/Carbon Injection System

Design Features	Comments
Utilities	Power for ID Fan (60 hp), Combustion Air Blower (5 hp), Cooling Water Pump (3 hp) Compressed Air (50 scfm) Cooling Water (15 gpm)
Fuel	Natural gas (up to 8 MMBtu/h)
Passively Ventilated Tanks	Integration of the passively ventilated tanks in a tank farm required; Eliminates fugitive emissions
Operating Parameters	
Thermal Oxidation Unit	
Design Temperature	1800°F
Design Air Flows:	2000 scfm
Carbon Injection System	
Temperature	NP ⁽¹⁾
Humidity	NP ⁽¹⁾
Additional Equipment/Tanks Required	
Fans	Combustion air and exhaust air fans
Quench and pumps	For evaporative cooling
Auger Delivery /Baghouse System	For activated carbon delivery

⁽¹⁾ Vendor did not provide (NP).

3.10.3 Operational Considerations

Table 3-35 summarizes the operational considerations provided by the vendor.

Table 3-35. Operational Considerations for the Project Integration Thermal Oxidation/ Carbon Injection System

Operational Considerations	Comments
Monitoring Requirements	<ul style="list-style-type: none"> - 0 to 2 Operators required - Solids handling requirements - Environmental sampling
Maintenance Requirements	<ul style="list-style-type: none"> - Quarterly instrumentation calibration - Annual maintenance required for fans, pumps, carbon delivery system, baghouse rotary valve and instrumentation
Consumables	<ul style="list-style-type: none"> - Thermal oxidizer natural gas fuel - Powdered carbon

3.10.4 Secondary Waste

The Project Integration system generates used carbon removed from the baghouse containing adsorbed mercury and other products of incomplete combustion.

3.10.5 Safety/Regulatory

The safety and regulatory considerations are those identified in the literature discussion for thermal oxidizers (see Section 2.4.5), and for sorption systems (see Section 2.2.5).

3.10.6 Costs/Schedule

During the workshop, Project Integration speculated a rough order of magnitude cost estimate of \$5 million, or more, per tank farm to implement their proposed abatement technology.

Project Integration said the development/design path envisioned to implement their proposal would include: develop basis and specifications, deliver a proposal, provide an engineering package after award of proposal, purchase equipment and fabricate the integrated system, and oversee construction bids and project management. The vendor did not provide any estimate of duration.

3.10.7 Summary Rating

The Project Integration proposal uses two mature technologies, thermal oxidation and carbon adsorption. This approach addresses a robust range of the COPCs with estimated high removal efficiencies for VOCs but moderate removal efficiencies for Hg due to the use of a carbon injection system. The proposal does not address NO_x abatement. The lower proposed operating temperature – in contrast to the designs proposed by ALZETA/Anguill and John Zink – will achieve lower destruction efficiency. The proposal will likely achieve lesser control of mercury emissions due to use of the carbon injection approach. The system is a high cost, complicated design with moving parts and relatively high maintenance and operational requirements. Secondary waste generation consists of spent carbon powder that requires treatment and disposal. Safety analysis for the proposal needs to address the fuel source location in the tank farm. The technology requires pilot-scale testing to determine the efficiency of carbon injection to control mercury emissions; the proposal is sufficiently mature to advance to pilot testing without additional development. The authors deem the proposed design as less attractive due to lower projected removal efficiencies for mercury and lack of technology to control NO_x emissions.

Table 3-36 provides a summary of the evaluation of the Project Integration thermal oxidizer/carbon injection system using the evaluation criteria and metrics in the Introduction.

Table 3-36. Project Integration Thermal Oxidation/Carbon Injection System Evaluation Summary

Evaluation Criteria	Rating
<i>Technical Feasibility</i>	Yellow
<i>Design Features</i>	Red
<i>Operational Considerations</i>	Red
<i>Secondary Waste</i>	Yellow
<i>Safety/Regulatory</i>	Red
<i>Cost / Schedule</i>	Red

3.11 Comi Polaris

Comi Polaris (a North American partnership of Comi Condor and Polaris Engineering) proposed a treatment system composed of the following operations.

- Alkaline scrubber to remove NO_x.
- Acid scrubber to remove ammonia.
- Adsorbent column to remove mercury compounds.
- Cryogenic condenser used to remove remaining organics to approximately less than 50 ppm.
- Thermal oxidizer used to reduce emissions down to below the target concentrations.

Figure 3-7 provides a schematic of the process flowchart.

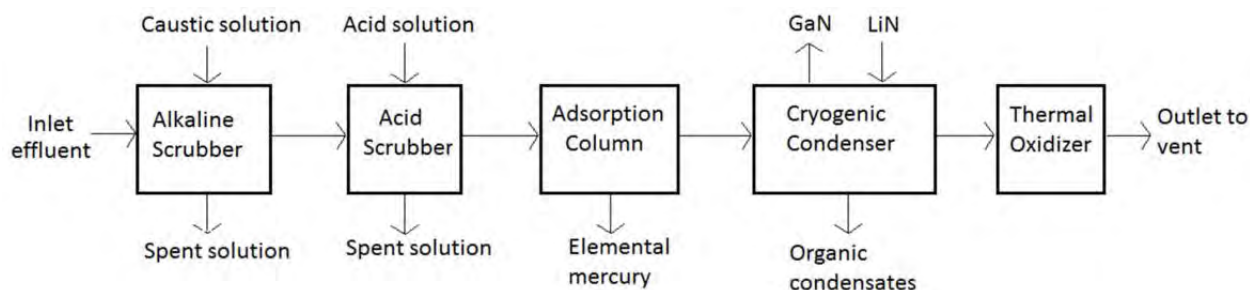

Figure 3-7. Conceptual Process Flowchart for Comi Polaris proposed Treatment System

3.11.1 Technical Feasibility

Since the last stage of the process is thermal oxidation, it is questionable whether the two scrubbers and cryogenic condenser are necessary stages. While the scrubbers and cryogenic condenser will remove significant amounts of the VOCs, the volume of gas treated by the thermal oxidizer does not change significantly; therefore, there is no cost savings realized from the use of a smaller oxidizer. However, there may be higher fuel costs associated with the oxidizer since the energy value of the treated stream is significantly less. Finally, the secondary waste from the scrubbers and condenser need treated.

Comi Polaris recommends a pilot program to supply needed information for a complete design.

3.11.2 Design Features

A typical cryogenic cooling system for a waste stream of 2000 scfm would have a footprint of 8 ft by 11 ft and 36 ft tall. The inlet temperature is assumed ambient and the inlet VOC concentration is assumed greater than 1000 ppm. To mitigate frosting and fouling of the heat exchanger, a dual heat exchanger system is used in which one is condensing liquids while the other is heated to remove buildup.

The design would need additional provision for liquid nitrogen supply. The vendor did not provide estimated sizes for the balance of the treatment stages.

Table 3-37 provides the vendor definition of design features.

Table 3-37. Design Features of Comi Polaris Proposal

Design Features	Comments
Infrastructure Requirements	
Footprint of System	66 ft long x 16 ft wide x 56 ft high
Utilities	Liquid nitrogen, electrical, chilled water, instrument air, dilute caustic solution, dilute acid solution
Passively Ventilated Tanks	Integration of ventilation system of single-shell tanks in tank farm
Operating Parameters	
Inlet Gas Flow	< 3000 scfm
Temperature	Ambient inlet
Inlet Concentration	> 1000 ppm VOCs
Additional Equipment Required (for Passively Ventilated Tank Farm)	
Exhaust Fans	Eliminates fugitive emissions and draws gases through system

3.11.3 Operational Considerations

This is a large and complex system. However, strategies for autonomous operation are well known and understood. The vendor will provide automated start up, operation, and shut down via PLC or similar

control structure. Monitoring for alarms is assumed, either locally or remotely. Remote monitoring necessitates regular operator rounds to assess physical condition and local indicators, nominally daily.

Standard maintenance protocols for rotating equipment and instrument calibration will be required. The volume of maintenance will vary somewhat based on final design input but it will be higher than other methods of abatement.

Table 3-38 provides the consumables for this system. The vendor estimated quantities only for the cryogenic condenser.

Table 3-38. Consumables for Comi Polaris Cryogenic Unit to Treat ~3000 scfm Hanford Off-gas

Consumable	Estimated Quantity
Liquid Nitrogen	30 – 130 scfm
Electrical Power	5 – 20 kW
Chilled Water	4 – 22 gpm
Instrument Air	0.5 – 4 scfm
Gaseous Nitrogen	0.5 – 2 scfm
Dilute Caustic Solution	Not provided by vendor
Dilute Acid Solution	Not provided by vendor
Natural Gas	Not provided by vendor
Activated Carbon	Not provided by vendor

3.11.4 Secondary Waste

This system generates several forms of secondary waste as shown in Table 3-39.

Table 3-39. Secondary Waste for Comi Polaris Proposed Treatment

Waste Form	Estimated Quantity
Dilute caustic solution with nitrate/nitrite salts	0.5 gpm, based on other vendor designs
Dilute acid solution with ammonium salts	0.5 gpm, based on other vendor designs
Mercury contaminated activated carbon	Dependent on design input
Condensed VOCs	Dependent on design input
NO _x	Dependent on concentration of nitrogen-bearing compounds in gas at inlet to thermal oxidizer

The system condenses the vapor contaminants to a liquid that must be further handled. A potential approach for final disposition to couple with condensation is a solidified waste form for landfill disposal. Another option may be shipment offsite to a commercial incinerator or oxidation facility. The project would need to perform a cost versus benefit assessment of options to provide a full conceptual design.

3.11.5 Safety/Regulatory

The safety and regulatory considerations include those identified in the literature discussion for thermal oxidizers (see Section 2.4.5), carbon adsorption systems (see Section 2.2.5), and wet scrubbers (see Section 2.5.5). In addition, the project would need to assess the safety and regulatory permitting associated with handling of the condensed VOCs and off-gas contaminants.

3.11.6 Cost/Schedule

The vendor did not provide cost estimates. When questioned at the workshop, vendor representatives indicated the cryogenic unit system cost could range from \$1 to \$1.5 million, without the nitrogen supply

system. The size and complexity of the system may result in higher capital costs compared to other technologies evaluated.

Operational costs will be high due primarily to the disposal of secondary waste in addition to the fuel costs for oxidizing a very dilute stream of VOCs. In addition, the design requires a cost evaluation to determine most cost effective approach to providing the liquid nitrogen.

Schedule information was not provided by the vendor but it is implied that these systems are built to order based upon design input provided by the customer; therefore, it is reasonable to expect fabrication of a system to require 6 months to 1 year after contract issuance.

3.11.7 Summary Rating

The Comi Polaris proposal incorporates cryogenic condensation into a system with absorption, adsorption, and thermal oxidation stages. Cryogenic condensation typically works best for high concentration gas streams in which the VOCs have economic value. The Hanford tank farm gas stream has relatively low concentrations of VOCs and recycling of the condensed streams is not economically viable; therefore, the authors see little value for the added burden of a cryogenic condenser for this application. Table 3-40 provides a summary of the evaluation of the Comi Polaris’ cryogenic condensation system using the evaluation criteria and metrics in the Introduction.

Table 3-40. Summary of Comi Polaris’ Cryogenic Condensation System Evaluation

Evaluation Criteria	Rating
<i>Technical Feasibility</i>	Yellow
<i>Design Features</i>	Yellow
<i>Operational Considerations</i>	Red
<i>Secondary Waste</i>	Red
<i>Safety/Regulatory</i>	Red
<i>Cost / Schedule</i>	Red

3.12 HGI Industries

HGI Industries (Boyton Beach, Florida) manufactures UV generators of hydroxyl radicals for the residential, medical, commercial, and industrial markets – including wastewater treatment, an ongoing trial at an aluminum recycling plant, and at automobile manufacturers. Demonstrated uses include treatment of ammonia, hydrogen sulfide, coolant gases, bacteria, and noxious vapors.

HGI proposes interfacing the ultraviolet hydroxyl generator with the tank headspace of passively ventilated tanks, producing hydroxyl radicals and ozone from UV irradiation of the water content of the vapor stream. The proposed system pulls air from the vapor space via a fan through the multi-frequency UV generator and disperses the mixture into the headspace. The ozone and radicals persist for a limited period, reacting further with the headspace contents.

3.12.1 Technical Feasibility

This vendor’s strategy uniquely proposes recirculating the headspace gas in the tank during treatment thereby reducing the contaminants at the source. The vendor is has successfully treated odors from wastewater and sludge using this approach.

The vendor’s preliminary assessment (see Table 3-41) indicates this technology does not treat mercury, nitrous oxide, or 2-fluoropropene. However, this preliminary assessment relied on subject matter expert

opinion and the vendor did not provide supporting literature or laboratory evidence. The process generates measurable amounts of NO_x.

Table 3-41. Predicted Ability of Treatment Technology to Achieve Targeted Performance for Chemical Classes in Hanford COPCs

Functional Group	Destruction Probability
Nitrates	Likely to be destroyed
Nitrites	Likely to be destroyed
Amines	Likely to be destroyed
Ammonia	Likely to be destroyed
Nitrous Oxide	No destruction expected
Pyridines	Likely to be destroyed
Phosphates	Likely to be destroyed
Mercury	No destruction expected
2-Fluoropropene	No destruction expected

Hydroxyl injection into the tank headspace is advantageous for passively ventilated tanks because of the low capital cost. However, the proposal did not address the treatment of tanks under active operation such as transfers or sampling that disturb the waste and release VOCs at higher rates. The vendor proposes determining the technology efficiency empirically to assess whether or not the production of hydroxyls can maintain VOC concentrations in the headspace below the target concentrations. Associated modeling of the vapor space air flows and a reaction model assuming variable VOCs source terms could potentially reduce the research and development.

3.12.2 Secondary Waste

Ultraviolet systems may generate additional NO_x.

3.12.3 Design Features

The footprint for a single generator is 3 ft² and 7 ft tall, and requires enclosure from the elements. The number of generators for treating a tank may vary with the size of the vapor space and the organic loading in the specific tank. The vendor did not provide a clear means to define the number of generators needed beyond field demonstrations to collect data.

The generators require 5 kW electrical power.

The design concept assumes ambient temperature for the inlet gas.

3.12.4 Operational Considerations

Ultraviolet systems are simple to operate. They do not require a high level of monitoring to maintain safe operations. Monitoring for alarms is assumed, either locally or remotely. Remote monitoring necessitates regular operator rounds to assess physical condition and local indicators, nominally daily.

Ultraviolet bulb light sources have a typical life of 6000 hours. The system proposed has 48 light bulbs. The maintenance frequency would be approximately 33 bulbs per year per generator. Periodic inspection and cleaning of the optics would be required.

3.12.5 Safety/Regulatory

The technology generates ozone that enters the headspace of the waste tanks. The fire hazard analysis will need to assess any risks from this added species. The analysis needs to consider estimated peak concentration. Analysis may need to assess vapor space flows.

The project would need to assess interactions between the radicals and installed instruments and headspace material of construction.

The injection of the ozone and radicals into the vapor space of the tanks poses an unanalyzed corrosion risk that needs evaluation.

3.12.6 Cost/Schedule

The vendor stated that a single 48-bulb generator costs approximately \$220,000. The corrosive nature of the off-gas from the vapor space may require more exotic materials of construction than used in the standard design.

The vendor did not provide information on schedule.

3.12.7 Summary Rating

HGI Industries proposes incorporating hydroxyl injection units into the headspace of passively ventilated tanks. Hydroxyl injection using ultraviolet light is an ineffective abatement technique for mercury and likely for 2-fluoropropene, according to the vendor's subject matter expert. The system does not abate NO_x and may generate additional NO_x. Destruction and removal efficiencies need determined empirically using representative gas streams. This technology requires significant development prior to introduction in a pilot program for the Hanford application. Table 3-42 provides a summary of the evaluation of the HGI Industries' hydroxyl injection system using the evaluation criteria and metrics in the Introduction.

Table 3-42. Summary of HGI Industries' Hydroxyl Injection System Evaluation

Evaluation Criteria	Rating
<i>Technical Feasibility</i>	Red
<i>Design Features</i>	Yellow
<i>Operational Considerations</i>	Yellow
<i>Secondary Waste</i>	Green
<i>Safety/Regulatory</i>	Red
<i>Cost / Schedule</i>	Yellow

3.13 Advanced Air Technologies

Advanced Air Technologies proposed treatment by:

- wet scrubbers using dilute nitric acid to treat ammonia, organic amines, water soluble mercury compounds, and nitrogen oxide,
- reheater to reduce relative humidity to < 50%,
- activated carbon dry adsorption beds to remove VOCs and organic mercury compounds, and
- sulfur-impregnated activated carbon for polishing removal of mercury compounds.

The design incorporates exhaust fans, mitigating risk of fugitive emission for the waste tanks, to draw tank vapors through the system.

3.13.1 Technical Feasibility

The vendor's proposed system of absorption (scrubbing) and adsorption technologies is designed to address all the targeted Hanford COPCs except for N₂O. The vendor did not provide information on projected removal efficiency for organo-mercury compounds. Advanced Air Technologies expects >99% removal efficiency for the inorganic vapors in the scrubber operations. The carbon adsorption systems can be designed to achieve high removal efficiencies of 95-99%. Table 3-43 includes both vendor-provided and literature removal efficiencies for these targeted groups. The vendor recommends pilot testing to verify the removal efficiencies.

Table 3-43. Advanced Air Technologies Projected Removal Efficiencies of Hanford Tank Farms Targeted COPC Groups

AAT's Proposed Technology Solution	VOCs	Dioxins/ Furans	NO _x	Ammonia	Mercury
Absorption					
Acid Gas Spray Scrubber (Amines, Ammonia, Soluble Hg species)	>99% for organic amines			>99%	>99% for elemental Hg
Adsorption					
Granular Activated Carbon (VOCs and Organic Hg)	98% ⁽¹⁾	95% to 98% ⁽¹⁾			95% for organic Hg
Total					
Absorption and Adsorption	>99%	95% to 98% ⁽¹⁾		>99%	>99% for elemental Hg; 95% for organic Hg

⁽¹⁾ Vendor indicated VOC removal efficiencies of 95% and literature indicated 95-98% for inlet concentrations > 500 ppm (U.S. EPA, March 2006)

3.13.2 Design Features

The vendor recommended sizing the system to accommodate the highest range of Hanford Tank Farm ventilation flows. Table 3-44 lists other proposed design features. The vendor recommended use of a heat exchanger using steam to pre-heat the gas stream prior the carbon sorption bed.

Table 3-44. Design Features of Advanced Air Technologies Scrubber/Carbon Bed Technologies

Design Features	Comments
Infrastructure Requirements	
Footprint of System	20 ft X 40 ft
Utilities	Water electrical (460 VAC three phase 60 Hz) 20 psia saturated steam
Passively Ventilated Tanks	Integration of the passively ventilated tanks in a tank farm required
Operating Parameters	
Scrubber System	
Air Flows	2000 scfm
Inlet Temperature	Recommended 40°F to 100°F
Pollutant Loading	Particulate loadings not critical in spray scrubbers operation
Reagents (liquids)	50 wt % nitric acid, and water
Carbon Beds	

Table 3-44. Design Features of Advanced Air Technologies Scrubber/Carbon Bed Technologies

Design Features	Comments
Relative Humidity	Relative Humidity: < 50%
Air Flows:	2,000 scfm
Temperature	Recommended < 100°F
<i>Additional Equipment Required</i>	
Exhaust Fans	Mitigates fugitive emissions and draws gases through system
Mist Eliminator/Heater	Conditions air/reduces relative humidity for carbon beds

3.13.3 Operational Considerations

Table 3-45 lists the vendor’s input on operational and maintenance needs.

The vendor suggested no need for monitoring equipment. However, this claim is suspect given that other vendors recommend monitoring and some monitoring for operations and emissions performance is likely needed.

Table 3-45. Operational Considerations of Advanced Air Technologies Scrubber/Carbon Bed Technologies

Operational Considerations	Comments
<i>Monitoring Requirements</i>	- Continuous operational monitoring is not required
<i>Maintenance Requirements</i>	- Low maintenance is anticipated (~50 man-hours/year for carbon bed replacement) - Non-routine cleanout of salts from scrubber system - Non-routine sampling of carbon (to determine organic loading)
<i>Consumables</i>	- Chemicals for scrubbing system: nitric (volume will be determined based upon pilot testing.) - Used carbon and containers

3.13.4 Secondary Waste

Secondary waste will consist of scrubbing liquid and spent carbon. The vendor did not provide estimates of the generation rates for each waste type.

The liquid waste will require handling and ultimate disposal.

3.13.5 Safety/Regulatory

The scrubber wastes will contain mercury as will the used carbon. The classification and permitting for these streams need assessed.

The proposal did not address NO_x except for N₂O compounds. Selection of this approach will necessitate an examination of fate of these species.

3.13.6 Cost/Schedule

The vendor estimated an equipment cost range of \$150,000 to \$200,000 for a system.

Advanced Air Technologies recommends pilot one each of the unit operations (i.e., each acid scrubber and the carbon sorption bed) scaled to 200 scfm to provide input for final design.

3.13.7 Summary Rating

The Advanced Air Technology proposal integrates mature absorption and adsorption technologies to address a robust range of the COPCs with estimated moderate to high removal efficiencies. The technology proposed is similar to that of HEE/Duall but without control of NO_x emissions. Use of carbon adsorption enables high removal efficiencies for VOCs. The system is of moderate capital cost using scrubbing technology followed by carbon adsorption. The vendor anticipates relatively moderate generation rates of liquid wastewater (one scrubber stage vs. three scrubber stages used in HEE/Duall), with rates needing confirmation by pilot testing. The scrubber removal efficiencies also need confirmation through pilot testing since each scrubbing system (i.e., pollutant and absorbing solvent) is unique. Integration into multiple tank farms will require substantial investment in infrastructure. A final disposition path for the resulting liquids will add costs and require additional permitting. The technology is sufficiently mature to proceed to pilot demonstration, if desired.

Table 3-46 provides a summary of the evaluation of the Advanced Air Technologies system using the criteria and metrics in the Introduction.

Table 3-46. Summary of Advanced Air Technologies Absorption/Adsorption System Evaluation

Evaluation Criteria	Rating
<i>Technical Feasibility</i>	Yellow
<i>Design Features</i>	Yellow
<i>Operational Considerations</i>	Yellow
<i>Secondary Waste</i>	Red
<i>Safety/Regulatory</i>	Red
<i>Cost / Schedule</i>	Yellow

3.14 Bionomic Industries

Bionomic Industries proposes the following sequential operations for treatment of the Hanford Tank Farm vapor COPCs:

- activated carbon adsorption for VOCs removal,
- chemically treated carbon bed for Hg removal,
- wet scrubber packed towers (using sulfuric or phosphoric acids) for ammonia gas and soluble amines removal,
- thermal oxidation for destruction of remaining VOCs,
- (optional) NO_x selective catalytic reactor for NO_x abatement, and
- (optional) quench / wet scrubber polisher.

The wet gas, packed bed scrubbing system will form neutral salts such as ammonium sulfate or phosphate. Bionomic did not provide any system for heat recovery. Bionomic will subcontract the thermal oxidizer and catalytic reactor, relying on that designer to make final recommendation on need for catalytic reactor. Similarly, the proposal allows for a quenching to reduce the temperatures exiting the NO_x reducer prior to exiting the stack, if necessary.

3.14.1 Technical Feasibility

The Bionomic system should attain removal efficiencies for VOCs of at least 99% with the combined thermal, catalytic, scrubbing and carbon systems. The chemically treated carbon (i.e., sulfur-impregnated) removes the elemental and oxide forms of mercury at significantly greater weight loadings than organo-mercury forms. (Saunders, 2016) However, the activated carbon stage will remove the organic mercury

(e.g., dimethyl mercury) at efficiencies estimated for VOC removal of 95% to 98%. (U.S. EPA, March 2006) Therefore, very little mercury (i.e., <3%) will enter the thermal oxidizer and disassociate into the more soluble forms for removal in the optional downstream scrubber stage.

The proposal provides abatement for all targeted Hanford Tank Farm COPCs. Table 3-47 includes the estimated literature efficiencies for each of these targeted groups as the vendor did not provide specific efficiencies. The vendor did recommend piloting a 2000 scfm to confirm design and removal efficiencies.

Table 3-47. Bionomic Projected Destruction Removal Efficiencies of Hanford Tank Farms Targeted COPC Groups

NUCON's Proposed Technology Strategy	VOCs	Dioxins/ Furans	NO _x	Ammonia	Mercury
Carbon Adsorption (Chemical & GAC)					
GAC	95% to 98% ⁽¹⁾	95% to 98% ⁽¹⁾			
Sulfur-Impregnated Activated Carbon					95% to 99% ⁽¹⁾
Scrubbing					
Wet Packed Tower Scrubber	NP ⁽²⁾			NP ⁽²⁾	
Thermal Oxidation					
Thermal Oxidizer	99% ⁽¹⁾	99% ⁽¹⁾			
Selective NO_x Reduction					
Selective Catalytic Reactor			NP ⁽²⁾		
Total					
Carbon Adsorption, Scrubbing, Thermal Oxidation, Catalytic Conversion	99% ⁽¹⁾	99% ⁽¹⁾	NP ⁽²⁾	NP ⁽²⁾	95% to 99% ⁽¹⁾

⁽¹⁾ Literature Source for inlet concentrations > 500 ppm (U.S. EPA, March 2006) and vendor provided removal efficiencies in Section 3.9.1

⁽²⁾ Vendor did "not provide "(NP)

3.14.2 Design Features

Bionomic proposes to provide a turn-key, skid-mounted system that integrates all of the air pollution control technologies and the necessary controls, piping, and fabrication. Table 3-48 contains the design features provided by the vendor.

Table 3-48. Design Features of the Bionomic Multi-Technology Abatement System

Design Features	Comments
Infrastructure Requirements	
Footprint of System	50 ft x 15 ft
Utilities	Water-5gpm; Power -460V / 3 phase / 60 Hz @20 kW; 220 V
Fuel Requirements	Natural Gas 2,000,000 Btu-hours @ 10 psig
Operating Parameters	
Carbon Units, Scrubber, Thermal Unit, NO_x Reducer	
Temperatures	< 200°F for scrubbers (assumed polypropylene or Fiberglass)
Design Air Flows:	2000 scfm
Additional Equipment Required	
Fans	Combustion and Exhaust
Quench/Scrubber polisher	Optional

3.14.3 Operational Considerations

Table 3-49 operational considerations provided by the vendor.

Table 3-49. Operational Considerations for the Bionomic Multi-Technology Abatement System

Operational Considerations	Comments
<i>Monitoring Requirements</i>	Bionomic indicated “routine” monitoring: <ul style="list-style-type: none"> - Daily monitoring of 4-5 times because of multiple systems
<i>Maintenance Requirements</i>	Bionomic indicated “routine” and therefore, requirements are typical: <ul style="list-style-type: none"> - Monthly - Brief shutdown to replace any failed instrumentation, change filters, etc. - Annual Maintenance: Inspection of burner nozzles, set-point verification and interlocks. Replacement as required.
<i>Consumables</i>	<ul style="list-style-type: none"> - Thermal oxidizer fuel - Carbon Adsorbents/ carbon containers or filters - Scrubber liquids

3.14.4 Secondary Waste

The Bionomic proposed system will generate: used carbon adsorbent, including at least a portion contaminated with mercury, that will require toxic landfill disposal, and secondary scrubbing wastewater with ammonium or phosphate salts. Based on experience, the vendor estimated the secondary waste generation rate as less than 1 gpm.

3.14.5 Safety/Regulatory

The safety and regulatory considerations are those identified in the literature discussion for thermal oxidizers (see Section 2.4.5), carbon adsorption systems (see Section 2.2.5), and wet scrubbers (see Section 2.5.5).

3.14.6 Cost/Schedule

The vendor recommends piloting a 1000 to 2000 scfm system for approximately one month (minimum) to confirm and finalize design.

The vendor indicated that design and fabrication of the pilot unit likely requires no less and 8-9 months.

3.14.7 Summary Rating

The Bionomic proposal employs mature control technologies and provides abatement for all targeted Hanford Tank Farm COPC groups. The thermal oxidizer and catalytic convertor coupled with the scrubbing and carbon adsorption technologies provide 95 to 99% removal efficiencies for: VOCs, mercury, ammonia, and the amines. Selective NO_x reduction using a catalyst could provide up to 95% NO_x abatement; however, the design requires pilot testing to determine these destruction efficiencies. Bionomic plans to subcontract the thermal oxidizer fabrication and design; therefore, the cost is likely similar to that of NESTEC. The proposed system will be a high cost, complicated design with moving parts with relatively high maintenance and operational requirements. Secondary waste generation includes used carbon (with mercury contamination) and scrubbing wastewater that increases the overall proposal cost. The amount of carbon is likely relatively high with the carbon positioned first for removing most of the VOCs. The design will need to address the safety issues for fuel location to support the oxidizer. The technology is sufficiently mature to deploy at pilot scale without additional development or testing. The number of technologies included and the sequencing raises questions about the need for this complexity.

Table 3-50 provides a summary of the evaluation of the Bionomic multi-technology system using the evaluation criteria and metrics in the Introduction.

Table 3-50. Summary of Bionomic Multi-Technology System Evaluation

Evaluation Criteria	Rating
<i>Technical Feasibility</i>	Yellow
<i>Design Features</i>	Red
<i>Operational Considerations</i>	Red
<i>Secondary Waste</i>	Red
<i>Safety/Regulatory</i>	Red
<i>Cost / Schedule</i>	Red

3.15 B&W MEGTEC

B&W MEGTEC’s proposed solution contains three main unit operations: thermal oxidation, selective reduction of NO_x, and carbon bed adsorption.

- Thermal Oxidation: A direct thermal oxidizer will process the exhaust from the tanks. The vendor notes that with relatively low Hanford flowrate, oversizing the oxidizer to provide additional residence time will yield higher destruction efficiencies.
- Selective NO_x Reduction: Oxidation of nitrogen containing compounds and the firing of the oxidizer burner will generate NO_x. A design should evaluate two options for treating NO_x, depending on required efficiency. Selective non-catalytic reduction (SNCR) is the most economically viable but provides less removal. Selective catalytic reduction (SCR) will provide more NO_x removal at higher capital cost. Both systems use ammonia injection in a duct to eliminate NO_x. The SCR requires a heat exchanger upstream of the SCR to cool the exhaust air from the oxidizer. This heat exchanger would also preheat the inlet tank vapor stream to the oxidizer.
- Carbon Bed Adsorption: After NO_x elimination, the exhaust design will cool, and potentially dehumidify the gas stream. A carbon bed would then remove mercury, along with further removal of the heavier organic compounds.

Figure 3-8 shows a typical B&W MEGTEC thermal oxidizer system.



Figure 3-8. B&W Thermal Oxidizer

3.15.1 Technical Feasibility

B&W MEGTEC indicated that their proposed thermal oxidation technology does not usually operate to achieve ultra-low exhaust concentrations (i.e., ppb and ppt range) and the vendor would not provide a written guarantee on the destruction efficiency of the system. However, the complete system design aims to maximize removal for all of the COPCs. Limited removal may occur for chemicals with very low inlet concentrations and performance needs assessed in a piloting phase of the project. Specifically, the direct thermal oxidizer can achieve 99.9% destruction on organic compounds when inlet concentrations are at least in the 50-100 ppm range. Heavy organic compounds will achieve higher removals via the carbon bed.

The SNCR system proposed by B&W MEGTEC will achieve 70% NO_x removal, while SCR systems will achieve 90%-95% NO_x removal. The higher removal comes at the cost of some ammonia slip, which will depend on the total flowrate of the system.

Table 3-51 includes both vendor-provided and literature removal efficiencies for the targeted COPC groups.

Table 3-51. B&W MEGTEC’s Thermal Oxidation/Selective NO_x Reduction/Carbon Adsorption System Removal Efficiencies of Hanford Tank Farms Targeted COPC Groups

B&W MEGTEC’s Proposed Abatement Technologies	VOCs	Dioxins/ Furans	NO _x	Ammonia	Mercury
Thermal Oxidation (2000°F to 2400°F)					
Direct Thermal Oxidizer	> 99.9%	> 99.9%		99.9%	Organic Hg ⁽¹⁾
Selective NO_x Reduction					
Selective Catalytic or Non-Catalytic Converter			70% to 95%		
Carbon Adsorption					
Chemically Treated for Hg (and Heavy Organics)					99% ⁽²⁾ for elemental and oxides
Total					
Absorption and Adsorption	> 99.9%	> 99.9%	70% to 95%	99.9%	99% ⁽¹⁾

⁽¹⁾ Note: Organic mercury is disassociated in the oxidizer generating CO₂, H₂O, and Hg (elemental and oxides)

⁽²⁾ Provided by literature and carbon vendors (see Section 3.9.1)

3.15.2 Design Features

B&W MEGTEC proposes to provide a turn-key, skid-mounted system that integrates a direct fired thermal oxidation unit, SCR or SNCR, and carbon adsorption and the necessary controls, piping, and fabrication. B&W MEGTEC designed the system on a flowrate of less than 10,000 scfm, to address uncertainty in the number of tanks treated together. The system footprint depends entirely on the total inlet flowrate. The oxidizer and carbon bed are essentially standalone pieces of equipment. The NO_x elimination requires an ammonia storage tank and ductwork. Table 3-52 summarizes design features provided by the vendor.

Table 3-52. Design Features of the B&W MEGTEC Thermal Oxidation/Selective NO_x Reduction/Carbon Adsorption System

Design Features	Comments
Infrastructure Requirements	
System Footprint	20 ft x 20 ft for 2000 to 3000 scfm
Utilities	Electricity (480V / 3 phase / 60Hz assumed), compressed

Table 3-52. Design Features of the B&W MEGTEC Thermal Oxidation/Selective NO_x Reduction/Carbon Adsorption System

Design Features	Comments
	air, aqueous ammonia solution, and potentially water if a water coil is selected for the heat exchanger downstream of the NO _x elimination, control system
Fuel	Natural gas (4 million Btu/h assuming 40% heat recovery)
Passively Ventilated Tanks	Integration of the passively ventilated tanks in a tank farm required
Operating Parameters	
Thermal Oxidation Unit	
Design Temperature	2000°F to 2400°F
Design Air Flows:	>10,000 scfm; 2 s residence time
Selective NO_x Reduction (SNCR or SCR)	
Temperature	SNCR Inlet: 1600°F to 1900°F SCR Inlet: 600°F to 700°F
Carbon Adsorption	
Temperature	Inlet: 150°F
Humidity	Max. inlet: < 50%
Additional Equipment/Tanks Required	
Fans	Combustion air and Exhaust air fans
Air Cooling (Heat Exchangers)	1 st Heat Exchanger upstream of SCR system and used to preheat inlet air to oxidizer 2 nd Heat Exchanger downstream of NO _x reduction to cool for carbon adsorption.
Ammonia Storage Tank & NO _x Analyzer	For Selective NO _x Reduction

3.15.3 Operational Considerations

Table 3-53 lists operational considerations provided by the vendor.

Table 3-53. Operational Considerations for the B&W MEGTEC Thermal Oxidation/Selective NO_x Reduction/Carbon Adsorption System

Operational Considerations	Comments
Monitoring Requirements	- Control system designed for remote monitoring to allow all equipment to operate with minimal operator interaction: temperature, air flows, and NO _x for ammonia injection
Maintenance Requirements	- Recommend Annual PM Maintenance Visits: Inspection of burner nozzles, set-point verification and interlocks. Replacement as required.
Consumables	- Oxidizer Natural Gas fuel - Ammonia for SCR/SNCR - Carbon /Carbon Containers

3.15.4 Secondary Waste

The B&W MEGTEC proposed abatement system will generate minimal secondary waste. Since the carbon bed is downstream of the thermal oxidation unit, few organics will reach the carbon bed. Therefore, carbon will primarily serve to adsorb mercury and as a “polishing” unit for products of incomplete combustion from the thermal oxidizer.

3.15.5 Safety/Regulatory

The safety and regulatory considerations are those identified in the literature discussion for thermal oxidizers (see Section 2.4.5) and carbon adsorption systems (see Section 2.2.5).

The B&W MEGTEC design places the carbon bed after oxidation, mitigating the risk of high adsorption heat compounds reaching the bed and posing a fire risk. This approach may simplify safety related monitoring and controls.

Use of a SCR for NO_x combustion may results in higher ammonia emissions.

3.15.6 Costs/Schedule

B&W MEGTEC did not provide either a budgetary proposal or schedule estimate.

They noted that if performance shows a lower thermal oxidizer efficiency coupled with the downstream adsorption meeting performance needs, then substitution of a regenerative thermal oxidizer can dramatically lower fuel usage (to ~0.35 million Btu/h).

B&W MEGTEC proposes piloting the recommended abatement strategy on a single tank farm first using a minimum flow of 2000 scfm to avoid the need to assess scale-up in final design. B&W MEGTEC also recommended technical discussions between all parties would be essential for successful execution of the project due to the ultra-high removal efficiencies (i.e., beyond industry standards) required for a variety of the COPCs.

3.15.7 Summary Rating

The B&W MEGTEC proposal employs a thermal oxidizer, catalytic convertor, and carbon absorption to provide abatement for all targeted Hanford Tank Farm COPC groups. The use of high temperature thermal oxidizer and catalytic convertor coupled with carbon adsorption technologies will provide > 99.9% removal efficiencies for VOCs and 99% removal efficiencies of all mercury species, ammonia, and the amines. The catalytic convertor provides NO_x abatement; however, the design requires pilot testing to determine the NO_x destruction efficiencies. The system, like other proposals that include thermal oxidizers, is a high cost, complicated design with moving parts and relatively high maintenance and operational requirements. Secondary waste generation will include both scrubbing wastewater and used carbon. The design will provide reduced carbon generation comparable to other vendor proposals with carbon as the only VOC abatement technology or those that are upstream of the oxidizer. Fuel source location adds complexity to the safety analysis. The technologies are sufficiently mature to demonstrate pilot-scale scale without additional development or testing.

Table 3-54 provides a summary of the evaluation of the B&W MEGTEC thermal oxidizer/selective NO_x reduction/carbon adsorption system using the evaluation criteria and metrics in the Introduction.

Table 3-54. Summary of the B&W MEGTEC Thermal Oxidation/Selective NO_x Reduction/Carbon Adsorption System Evaluation

Evaluation Criteria	Rating
<i>Technical Feasibility</i>	Yellow
<i>Design Features</i>	Red
<i>Operational Considerations</i>	Red
<i>Secondary Waste</i>	Yellow
<i>Safety/Regulatory</i>	Red
<i>Cost / Schedule</i>	Red

3.16 Strobic Air

Strobic Air proposes abatement of the Hanford Tank Farm COPCs based upon the principal of dispersion and dilution. Strobic Air suggests use of a Tri-Stack[®] exhaust system for the Hanford Tank Farm ventilation systems. The following benefits will be provided by implementation of the system:

- reduction of fugitive Emissions from passive ventilated tanks,
- dilution of Hanford Tank Farm COPCs (dilution factors in the range of 150 to 250), and
- dispersion of COPCs via high velocity jet (to 40 to 150 ft elevation depending on flow rates) (Strobic Air).

The Strobic Air Tri-Stack[®] exhaust system as shown in Figure 3-9 is a direct drive mixed-flow impeller system that mixes contaminated exhaust air with unconditioned, outside ambient air via a bypass mixing plenum and bypass dampers. The diluted process accelerates through an optimized discharge nozzle/wind band with nearly twice as much additional fresh air entrained into the exhaust plume before leaving the fan assembly. The exhaust plume entrains additional fresh air after it leaves the fan assembly through natural aspiration. Because free outside air is introduced into the exhaust airstream, a substantially greater airflow is possible for a given amount of exhaust providing excellent dilution capabilities and greater effective stack heights over conventional centrifugal fans without additional horsepower.

The fans typically require only 60% of the stack height of a conventional ventilation fan. (Strobic Air)

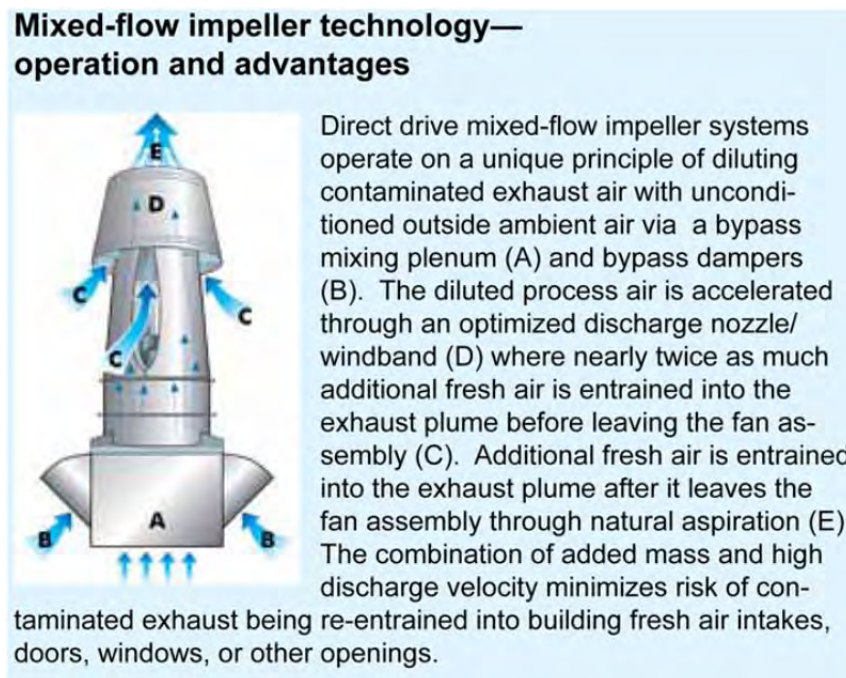

Figure 3-9. The Strobic Air Tri-Stack[®] Exhaust System

3.16.1 *Technical Feasibility*

Treatment of the off-gas from passively ventilated waste at Hanford requires new infrastructure. The conceptual approach involves pulling flow through a piping system that links tanks in a single tank farm (or geographical vicinity) to a common ventilation stack. Using the Strobic Air Tri-Stack[®] as the motive force provides better dispersion and added dilution beyond a conventional centrifugal fan.

As an example, a mixed-flow fan moving 80,000 cfm of combined building and bypass air at an exit velocity of 6300 ft/min can send an exhaust air jet plume up to 120 ft. high in a 10 mph crosswind. Since

the fan induces 170% of outside air into the exhaust airstream, a substantially greater airflow is possible for a given amount of exhaust providing excellent dilution capabilities and greater effective stack heights over conventional centrifugal fans without additional horsepower. (Livingstone, 2008) In another case, two Tri-Stack[®] fans rated at 20 hp and 15 hp, respectively, with the 20 hp fan operating at about 7,600 cfm projected the exhaust stream at a nozzle velocity of over 4,600 ft/min, allowing it to rise to a height of approximately 65 feet above the roofline, providing effective dissipation. (Strobic Air, 2016 August)

This technology provides a reduction in concentration for all COPCs. To achieve the dilution of all species to <10% of the OEL will most likely require placing a number of fans in parallel for a given tank farm grouping. The vendor suggested an arrangement of 10 fans of the TS-4 M58 design (i.e., each fan with 53,800 cfm capacity and 58 inch impellers). Dispersion modeling will confirm if the levels meet the performance requirements.

3.16.2 Secondary Waste

The Tri-Stack[®] exhaust system does not generate secondary waste.

3.16.3 Design Features

Strobic Air Tri-Stack[®] exhaust systems are available in a range of sizes ranging from 3,240 to 82,000 cfm using between 3 and 100 hp. The maximum static pressure ranges from 5.1 to 10.7 in w.g. The vendor suggested an arrangement of 10 fans of the TS-4 M58 design (i.e., each fan with 73,000 cfm capacity and 58 inch impellers). These fans use a 75 hp motor. The design would likely include booster fans for the off-gas inlet. The fans exhaust the off-gas at 7,000 ft/min and have a theoretical equivalent stack height of 100 ft.

The fans operate on 115 VAC / 15 amp with a normal temperature range of 32°F to 122°F.

Installation requires a ventilation plenum and structural support.

Strobic Air provides for integration of the Tri-Stack[®] fans with HEPA filters. (Strobic Air)

Strobic Air offers versions with corrosion resistant materials of construction as well as units for high temperature applications.

3.16.4 Operational Considerations

Strobic Air indicates low maintenance needs. The Tri-Stack[®] nozzle design allows the motor to remain outside of the hazardous exhaust stream, therefore allowing for easier maintenance and long life cycle. Direct drive motors eliminate the need to replace belts, pulleys, or other limited life components. A 7-year warranty is provided and the motor is rated for 20 years. The vendor indicates current systems have been operating for over 24 years.

3.16.5 Safety/Regulatory

Actively ventilated Hanford waste tanks currently use fan exhaust systems. Addition or substitution of the existing systems with a Tri-Stack[®] exhaust system adds no additional safety concerns.

The program may need additional dispersion modeling that includes pertinent bounding metrological conditions for individual tanks and for a combined tank farm system to assess benefit of the technology and finalize design.

3.16.6 Cost/Schedule

Strobic Air provided an order of magnitude cost estimate of \$90,000 to \$110,000 per fan. The vendor would supply the fans in an integrated skid for installation. Modular construction allows for easy

installation and low system pressures. Hence, the equipment cost per each grouping of ~8 tanks is roughly \$900,000 to \$1.1 million.

Vendor literature claims 48% lower annual operating costs than conventional centrifugal fans, with the bulk of the savings from reduced energy. (Strobic Air)

These Tri-Stack[®] exhaust system fans can be provided within 2 to 6 months after ordering.

3.16.7 Summary Rating

The Tri-Stack[®] fans will effectively dilute all emissions. The design is robust and extensively deployed. The technology is mature enough to assess deployment options and costs for the Hanford applications. Table 3-55 provides a summary of the evaluation of the Strobic Air Tri-Stack[®] exhaust system using the evaluation criteria and metrics (see Introduction).

Table 3-55. Summary of Strobic Air Tri-Stack[®] Exhaust System Evaluation

Evaluation Criteria	Rating
<i>Technical Feasibility</i>	
<i>Design Features</i>	
<i>Operational Considerations</i>	
<i>Secondary Waste</i>	
<i>Safety/Regulatory</i>	
<i>Cost / Schedule</i>	

4.0 Results and Discussion

The assessment indicates that abatement of the Chemicals of Potential Concerns (COPCs) requires more than a single technology. Table 4-1 shows the projected ability of the various technologies to meet the targeted performance for different chemical classes within the Hanford COPCs.

Table 4-1 Projected Ability of Treatment Technology to Achieve Targeted Performance for Chemical Classes in Hanford COPCs

Technology	VOCs	Dioxins/ Furans	NO _x	Ammonia	Mercury
Dispersion/Ventilation					
Tri-Stack Exhaust Fans					
Adsorption					
Activated Carbon (VOCs)					
Sulfur Impregnated Activated Carbon (Hg)					
Acid Impregnated Activated Carbon (NH ₃)					
Filtration / Membranes					
Sorbent Polymer Catalyst					
Catalytic Filter Bag (NO _x /NH ₃)					
Catalytic Filter Bag (Furan/Dioxin)					
Thermal Oxidation					
Internal Combustion Engine with Catalytic Convertor					
Flameless Thermal Oxidation					
Thermal Oxidation					
Selective (Catalytic or Non-Catalytic) Reactor					
Absorption					
Wet Scrubber (Caustic/Acidic)					

Table 4-1 Projected Ability of Treatment Technology to Achieve Targeted Performance for Chemical Classes in Hanford COPCs

Technology	VOCs	Dioxins/ Furans	NO _x	Ammonia	Mercury
NO _x 2-Stage Scrubber (Oxidative/Reductive)	RED	GREEN	GREEN	RED	RED
Ionic Liquid Scrubber	RED	RED	RED	RED	YELLOW
Non-Thermal Destruction					
Non-Thermal Plasma	YELLOW	GREEN	YELLOW	RED	RED
Ultra-Violet (Catalytic or Non-Catalytic)	YELLOW	GREEN	RED	RED	RED
Condensation					
Cryogen	GREEN	GREEN	GREEN	YELLOW	YELLOW
Aerosol/Particulate Control					
Wet Electrostatic Precipitator	RED	RED	RED	RED	RED
GREEN = expected to meet target; YELLOW = uncertain can achieve target; RED = unlikely to meet target					

The use of a thermal oxidizer will provide adequate destruction of the greatest number of volatile organic constituents. Removal of NO_x gases will require separate provisions either in the selection of the oxidizer design or via a separate aqueous scrubbing technology. Post scrubbing the off-gas with dry bed sorbents (or filter media) will provide trapping and reduction in concentration of the mercury and of any organic species that survive the oxidation step.

The vendors provided numerous conceptual flowsheets for the vapor abatement. In addition, vendors supplied responses on the COPCs treated with estimated ability to meet a target of no greater than 10% of the Occupational Exposure Limit, the operating parameters, the approximate footprint, utility requirements, maintenance, controls, and operator needs. Vendors identified secondary waste stream generation, if any. They provided evidence of prior experience and recommendation on need for piloting. Some vendors provided rough order of magnitude cost information. Vendors stated whether they have experience in complying with NQA-1 (or similar) nuclear regulations. Most vendors had limited or no experience with NQA-1 implementation. The NUCON International team possesses a strong understanding of NQA-1 from past interactions in deployments at the Oak Ridge National Laboratory Spallation Facility. The Strobic Air team lead for Quality Assurance has prior relevant work history in delivering items for NQA-1 applications. The HGI Industries team noted plans to team with a local Hanford supplier (White Shield Incorporated) should their proposal advance. Many of the vendor teams showed evidence of delivering equipment to meet regulations from Environmental Protection Agency and other governing agencies.

Although most vendors projected a high removal or destruction efficiency for the listed COPCs, it remains to be determined whether reduction of concentrations for all constituents to less than 10% of the respective Occupational Exposure Limits (OELs) is economically practicable. For some COPCs, this target may exceed the industry standard, where destruction removal efficiencies (DREs) exceeded the regulatory requirements. It is possible to “over-design” a system, thereby adding cost, complexity, and excessive maintenance needs.

The SRNL facilitated a rating evaluation of the various vendor proposals at the workshop. Subsequent to the workshop, SRNL led conference calls with three additional vendors. Furthermore, SRNL and the WRPS Technical Lead visited three vendors (recommended by SRNL) for additional discussions: W. L. Gore & Associates (29 August), NUCON International (30 August), and Strobic Air (1 September). The SRNL authors used the combined information from the workshop, conference calls, and vendor trips to provide a final ranking of the proposed treatments. Table 4-2 provides the consensus ratings from SRNL participants.

Table 4-2 Panel Evaluation of the Vendor Proposed Treatment Flowsheets.

Workshop Vendors	Technical Feasibility	Design Features	Operational Considerations	Secondary Waste	Safety / Regulatory	Costs / Schedule
Calgon Carbon	Yellow	Green	Green	Yellow	Green	Green
Hee-Duall	Yellow	Yellow	Yellow	Red	Red	Yellow
NESTEC, Inc	Yellow	Red	Red	Red	Red	Red
W.L. Gore	Red	Green	Green	Yellow	Yellow	Yellow
Schenk Process	Red	Green	Red	Red	Red	Red
ALZETA/Anguil	Yellow	Yellow	Yellow	Yellow	Red	Yellow
John Zinc Hamworthy	Red	Yellow	Red	Green	Red	Yellow
Beltran Inc.	Red	Red	Red	Red	Yellow	Red
NUCON	Yellow	Green	Green	Yellow	Red	Green
Project Integration	Yellow	Red	Red	Yellow	Red	Red
Comi Polaris	Yellow	Yellow	Red	Red	Red	Red
HGI Industries	Red	Yellow	Yellow	Green	Red	Yellow
Advanced Air Technologies	Yellow	Yellow	Yellow	Red	Red	Yellow
Bionomic Industries	Yellow	Red	Red	Red	Red	Red
B&W MEGTEC	Yellow	Red	Red	Yellow	Red	Red
Strobic Air	Green	Green	Green	Green	Green	Green

5.0 Recommendations, Path Forward and Future Work

The SRNL team concludes that the program needs to complete additional preparation before starting final design and deployment of vapor abatement technology. SRNL therefore recommends completing the following activities as precursors to final design and deployment.

- (1) The program lacks rigorous technical basis to establish performance metrics. The suggested target of less than 10% of the respective OELs is a credible initial conceptual standard. The program should further assess the health hazard posed by each COPC and the ability to monitor its presence at those concentrations before committing to this metric.
- (2) The program should conduct a review of the data set of measured vapor compositions to define a subset of species (a) that are tractable with existing mature monitoring technologies, (b) that spans the range of chemical behavior for the bulk of the vapor stream, and (c) that represents an engineering practical subset for assessing pilot scale demonstrations of the most promising abatement options.

Moderate ventilation upgrades for passive vented tanks is likely an essential step for any technology deployment to address fugitive vapor risk. Most of the tanks use passive ventilation and as such provide only a minimal driving force to remove volatile organic species that form from ongoing radiolysis. Converting these tanks to an active ventilation system provides a means to remove volatile organic compounds continuously and can reduce the buildup of vapors in the headspace and control potential fugitive leak paths for these vapors. All vendors recommended options that required an active ventilation system and SRNL endorses that approach.

Implementation of any vapor abatement technology may well require permit modifications. Additional permits may prove necessary to address the secondary solid or liquid byproduct streams from treatment.

SRNL also recommends that the program further evaluate the following abatement options.

- (3) Strobic Air designs and deploys high velocity fans for dispersion of off-gas streams from process operations and laboratories. These fans avoid the need for excessively tall stacks due to the velocities involved. SRNL recommends conducting air dispersion modeling to both optimize the fan system design and provide a basis for comparison of these high performance fans to conventional fans in current use in the active ventilation systems. SRNL recommends performing a study to develop conceptual designs for deployment of these fans in the Hanford ventilation systems, if warranted, based upon the results of the modeling.
- (4) NUCON International proposed the use of a conventional internal combustion engine with a catalytic converter as the core of the treatment. The off-gas stream passes through dry sorbent beds for removal of mercury and an optional carbon bed for trapping residual organic compounds. This approach is the simplest approach suggested for an oxidizer. NUCON is internally funding a pilot test. SRNL recommends providing direct technical consultation and monitoring of the test program (by project personnel and SRNL staff members).
- (5) Use of dry carbon sorbent beds is the simplest and most robust means for trapping the largest numbers of volatile compounds identified in the Hanford ventilation stream. The majority of vendors included dry sorbent beds as a stage in the proposals. However, W. L. Gore and Associates included use of catalytic oxidation of furans and dioxins along with treatment of NO_x gases. Gore's catalytic oxidation modules also include dry sorbent material for maximum removal efficiencies. Discussions with the vendor noted that their experience indicates other organics also show partial decomposition under the catalytic treatment of the furans and dioxins at relatively moderate temperatures. Electrical heating becomes more practical at these moderate temperatures and, therefore, eliminates the need of a fuel source located in the tank farms which is a clear disadvantage of the oxidation proposals. SRNL proposes further assessment and laboratory tests in FY17 to develop a combined catalytic oxidation and dry bed sorption treatment. SRNL will lead this effort, working with Gore and Calgon Carbon to design the treatment approach.
- (6) Selection of the treatment option for mercury removal needs additional investigation and SRNL proposes assessing three options before final design. Common industrial practice often employs activated carbon such as offered by Calgon Carbon. NUCON International deployed a proprietary dry bed sorbent at Oak Ridge National Laboratory Spallation facility that may produce less secondary waste. W. L. Gore and Associates provided evidence of extensive deployments of flow-by filter media for removal of mercury from off-gas streams with even more savings in waste as well as simplicity in deployment. One technical unknown for this third media is the extent of trapping and interference posed by volatile organics. SRNL proposes that its staff work with Gore personnel and obtain test data on the performance under conditions relevant to the Hanford application.
- (7) SRNL recommends the project continue assessment of technologies in FY17 leading to full-size, parallel demonstrations of the two most promising technologies. Siting of the demonstration should consider a passively ventilated tank. Selection of a passively ventilated tank offers a higher probability of containing elevated concentrations of trapped VOCs and gases, posing a greater challenge to the technologies. In addition, selection of a passively ventilated tank may provide less interference with already planned activities for tanks, allowing limiting the operations to only those associated with this program. NUCON should lead design of the equipment for that option while SRNL prepares the skid for the combined

catalytic oxidation and dry sorbent bed approach. The design should include pre- and post-analysis of the air stream composition using methods currently deployed by the program. SRNL recommends planning for a demonstration period of one year. The long duration will help ensure the technologies experience the full range of emissions behaviors. Testing should include at least one period of deliberate disturbance (i.e., mixing) of the waste.

6.0 References

- Anit, S. B., & Artuz, R. J. (n.d.). *Biofiltration of Air*. Retrieved from Renneslaur Polytechnic Institute Department of Chemical Engineering: <https://www.rpi.edu/dept/chem-eng/Biotech-Environ/MISC/biofilt/biofiltration.htm>
- Archabal, S. a. (1994). *A Performance and Cost Evaluation of Internal Combustion Engines for The Destruction of Hydrocarbon Vapors from Fuel Contaminated Soils*. Air Force Center for Environmental Excellence (AFCEE) Technology Transfer Division.
- Bartz, D. M. (May 1996). Destruction of Halogenated VOCs Using Premixed radiant Burner. *Proceedings of the International Conference on Incineration and Thermal Treatment Technologies*.
- Boardman, R. a. (February 2002). Idaho National Engineering and Environmental Laboratory High Temperature MACT Calcination Test, Status Report. INEEL.
- Broderick, T. (31 December 2002). Spallation Neutron Source Carbon Adsorption Tests, Final Report. ADA Technologies Inc.
- Bryant, C., Xu, Z., & Kotts, J. (2016). The Most Cost-effective Way to Meet Dioxin Regulations.
- Burns, H. F. (June 2016). *Vapor Abatement Technical Strategy Plan for Washington River Protection Solutions (WRPS) Requisition #287074*. Savannah River National Laboratory.
- Campbell, M. (2016, July 11). John Zink Thermal Oxidizer System Budget Technical Proposal for Heather Burns. *TG-201605-65355-A0*. Tulsa, OK.
- Chmielewski, A. G., Licki, J., Pawelec, A., Tyminski, B., & Zimek, Z. (2004, March). Operational experience of the industrial plant for electron beam flue gas treatment. *Radiation Physics and Chemistry*, pp. 439-442.
- Comi Polaris Systems. (n.d.). Cryogenic Condensation.
- Dean, V. A. (1997). Induction-Coupled Plasma Used to Destroy CFCs in Japan. *Air Pollution Consultant*, 1.11-1.12.
- Del Debbio, J. W. (2003). Sulfur-Impregnated Granulated Activated Carbon (GAC) for Mercury Removal from NWCF Off-Gas, Status Report. INEEL.
- DOE Office of Environmental Management. (15 September 2011 Change 1). *Technology Readiness Assessment Guide*. Washington DC: DOE.
- Dwivedi, P., Gaur, V., Sharma, A., & Verma, N. (2004). Comparative study of removal of volatile organic compounds by cryogenic condensation and adsorption by activated carbon fiber. *Separation and Purification Technology*, 23-37.
- Gans, C. (2006, August). Consider Mixed-Flow Impeller Technology for Odor Management. *Chemical Engineering Progress*.
- Integrated Environmental Technologies, LLC. (8 June 2004). Personal Communication.
- Jones, A. P., Hoffman, J. W., Smith, D. N., Feeley, III, T. J., & Murphey, J. T. (2007). DOE/NETL's Phase II Mercury Control Technology Field Testing Program: Preliminary Economic Analysis of Activated Carbon Injection. *Environmental Science & Technology*, 1365-1371.
- Khan, F. I. (2000). Review: Removal of Volatile Organic Compounds from Polluted Air. *Journal of Loss Prevention in the Process Industries*(13), 527-545.
- Linde North America, Inc. (2016). *Cryo-Condensation for Control of Storage tank VOC Emissions*.
- Livingstone, P. (2008, June). Mixed-Flow Exhaust Systems, Cut Vibration and Noise. *R&D Technologies and Strategies That Enable Research and Development*, 50(No. 3).
- Meacham, J. H. (May 2006). Industrial Hygiene Chemical Vapor Technical Basis. Richland, WA: CH2MHILL Hanford Group, Pacific Northwest National Laboratory.
- Moretti, E. C. (2002, June). Reduce VOC and HAP Emissions. *CEP Magazine, An AIChE Publication*, pp. 30-40.
- NUCON. (2012). MERSORB® Mercury Adsorbents Bulletin 11B28-2012.
- Oyama, S. T., & Hunter, P. (2000). *Control of Volatile Organic Compound Emissions: Conventional and Emerging Technologies*. New York: John Wiley & Sons.

- PlasTEP. (2012). *Plasma Treatment for Environmental Protection*. Tartu: PlasTEP.
- Saunders, R. o. (2016, August 16). Weight loadings elemental Hg vs organic Hg in chemically treated carbon. (H. Burns, Interviewer)
- Soelberg, N. E. (May 2011). *INL/CON-10-18125, Avoiding Carbon Bed Hot Spots in Thermal Process Off-Gas Systems*. Idaho National Laboratory.
- SRNL. (14 June 2016). *Base Notice: Commercially Mature Technologies for Treatment and Abatement of Chemical Vapors for Tanks - 05112016LKC*. FedBizOpps.gov. Retrieved from https://www.fbo.gov/index?s=opportunity&tab=archives&mode=list&_sfromactive=1
- Stock, L. H. (July 2004). *A Survey of Vapors in the Headspaces of Single-Shell Waste Tanks*. PNNL, Richland, WA.
- Strobic Air. (2016 August). Strobic Air Tri-Stack® Fans Address Brick Hospital Diesel Generator Exhaust Issues. *Products at Work*.
- Strobic Air. (n.d.). Bag-in/bag-out HEPA modules and filters for Tri-Stack® systems. Retrieved August 17, 2016, from <http://www.strobicair.com/literature-library#tab>
- Strobic Air. (n.d.). Strobic Air General Brochure. Retrieved August 17, 2016, from <http://www.strobicair.com/literature-library#tab>
- Strobic Air. (n.d.). Tri-Stack(R) Roof Exhaust System. Retrieved August 17, 2016, from <http://www.strobicair.com/literature-library#tab>
- Telebizadeh, P., Babaie, M., Brown, R., Rahimzadeh, H., Ristovski, Z., & Arai, M. (2014). The role of non-thermal plasma technique in NOx treatment: A review. *Renewable and Sustainable Energy Reviews*, pp. 886-901.
- U.S. EPA. (June 1998). *EPA-450/3-88-012 Carbon Adsorption for Control of VOC Emissions: Theory and Full Scale System Performance*. Office of Air Quality Planning and Standards, Research Triangle Park, NC.
- U.S. EPA. (March 2006). *Off-Gas Treatment Technologies for Soil Vapor Extraction Systems: State of the Practice*. Office of Superfund Remediation and Technology Innovation. Cincinnati: Office of Superfund Remediation and Technology Innovation.
- U.S. EPA, CATC. (May 1999). *EPA 456/F-99-004, EPA Technical Bulletin: Choosing an Adsorption System for VOC: Carbon, Zeolite, or Polymers?* Clean Air Technology Center.
- U.S. EPA, CTC. (May 1995). *EPA-456/R-95-003, Survey of Control Technologies for Low Concentration Organic Vapor Gas Streams*. Control Technology Center.
- U.S. EPA, Office of Air Planning and Standards. (Jan 2002). *EPA/452/B-02-001, EPA Air Pollution Control Cost Manual*. Research Triangle Park, NC.
- U.S. EPA-APPCD. (February 2005). *Control of Mercury Emissions from Coal-Fired Electric Utility Boilers*. Air Pollution Prevention and Control Division - National Risk Management Research Laboratory, Research Triangle Park, NC.
- U.S.EPA. (2003-1). *EPA-452/F-03-012,-15,-16, Air Pollution Control Control Technology Fact Sheet - Scrubbers*.
- US EPA. (2003). Catalytic Incinerator. *Air Pollution Control Technology Fact Sheet*. US EPA.
- US EPA, UNEP, SERI. (2014). *Mercury Emissions Capture Efficiency with Activated Carbon Injection at a Russian Coal-Fired Thermal Power Plant*. Geneva: United Nations Environment Programme.
- W. L. Gore & Associates. (2015). Upgrade your baghouse to an SCR. *GORE® DeNOx Catalytic Filter Bags*.
- W. L. Gore & Associates. (2016). The Most Cost-effective Way to Meet Dioxin Regulations. *Remedia Catalytic Filer System*.
- Wilmarth, W. M. (31 October 2014). *Hanford Tank Vapor Assessment Report*. Savannah River National Laboratory.
- WRPS. (3 February 2016). *Vapor Abatement Technology Study*. Richland, WA: Washington River Protection Services.

Appendix A. Request for Information

This Appendix contains a copy of the Request for Information as posted on the Fed Biz Opps website in final form.

Commercially Mature Technologies for Treatment and Abatement of Chemical Vapors for Tanks

Solicitation Number: 05112016LKC
Agency: Department of Energy
Office: Savannah River Nuclear Solutions, LLC
Location: Savannah River Nuclear Solutions, LLC

Notice Type:
Sources Sought
Original Posted Date:
May 16, 2016
Posted Date:
June 14, 2016
Response Date:
Jul 11, 2016 11:59 pm Eastern
Original Response Date:
Jul 11, 2016 11:59 pm Eastern
Archiving Policy:
Automatic, 15 days after response date
Original Archive Date:
July 26, 2016
Archive Date:
July 26, 2016
Original Set Aside:
N/A
Set Aside:
N/A
Classification Code:
B -- Special studies and analysis - not R&D
NAICS Code:
562 -- Waste Management and Remediation Services/562910 -- Remediation Services

Solicitation Number:
05112016LKC
Notice Type:
Sources Sought
Synopsis:
Added: May 16, 2016 4:56 pm Modified: Jun 14, 2016 3:29 pm [Track Changes](#)
NOTE: THIS MODIFICATION/AMENDMENT IS ISSUED TO REVISE THE TENTATIVE TECHNOLOGY ASSESSMENT WORKSHOP SCHEDULE, TO BE HELD IN THE AREA OF THE TRI-CITIES, WASHINGTON, TO JULY 19 - 21, 2016.

NEED

This request for information and interest seeks interested parties with current commercially mature technologies/methods of detection, monitoring, and abatement that could enhance the Hanford tank farm vapor management system. The 'Background' section below provides details of the classes of chemical compounds and approximate ranges of concentrations of interest. This request seeks definition of demonstrated and commercially mature technologies for treatment and abatement of

Commercially Mature Technologies for Treatment and Abatement of Chemical Vapors for Tanks - 05112016LKC - Federal Business Opportunities: Opportunities

the described tank vapors. The list includes multiple classes and groupings at varying concentrations. The expectation is that no single technology may exist to cover all the compounds and that vendors may identify multiple technologies to package together to provide the desired treatment. Parties are encouraged to provide information of prior testing, successful deployments, and any supporting literature for the suggested technologies. Savannah River National Laboratory (SRNL) and (Washington River Protection Solutions (WRPS)) will evaluate the submitted technologies with the intent to rank the relative merits and consider for a subsequent testing or demonstration program. SRNL and WRPS anticipate holding a workshop (in Richland, WA) approximately 6 to 8 weeks after issuance of this request to allow selected suppliers to provide a more detailed overview of the proposed technology(ies). In parallel, SRNL will conduct interviews with suppliers. For especially promising technologies, SRNL and WRPS may entertain offers to visit existing testing laboratories or vendor deployments to observe firsthand the efficacy and operation of these technologies.

BACKGROUND

The Hanford Site tank farms contain millions of gallons of mixed radioactive and chemical waste stored in numerous underground tanks located in distinct tank farms. The mission of WRPS is to "safely retrieve Hanford's tank waste and close the Tank Farms to protect the Columbia River." For additional information, visit the WRPS website (www.wrpstoc.com).

The primary goals of the WRPS are to:

1. Safeguard our workers, the surrounding communities, and the environment;
2. Achieve the mission in full compliance with applicable regulations and requirements;
3. Implement the safest, most-efficient, and cost-effective methods to achieve the mission; and
4. Foster a robust nuclear safety culture by practicing candid and open communications, mutual respect, a questioning attitude and positive and proactive collaboration.

The chemical vapor hazards management program is one example of WRPS implementing a comprehensive Integrated Safety Management System (ISMS). ISMS is a core guiding principle of WRPS for protecting the safety and health of the tank farm workers, the public, and the environment. WRPS commissioned an independent Tank Vapor Assessment Team (TVAT) to examine hazardous chemical vapors management and related worker protection measures, and recommend actions to eliminate or mitigate vapor exposures. The TVAT hypothesized that under certain conditions vapors coming out of tanks in high concentration plumes sporadically intersected with the breathing zones of workers. To address the TVAT report recommendations, WRPS developed an implementation plan that provides a phased approach to address the recommendations via proposed response actions.

The tank waste generates vapors from a combination of thermal, chemical, and radiolytic processes. Prior and ongoing sampling and analysis programs provide a list of 59 Chemicals of Potential Concern (COPCs, see Attachment A) that are of greatest interest. Primary chemicals of concern include the following chemicals / compounds:

Ammonia
Nitrous oxide
Nitroso dimethyl amine
Mercury (elemental)

https://www.fbo.gov/...?opportunity&mode=form&id=2718640587513e8a8e1b3d6a16f07805&tab=core&tabmode=list&print_preview=1[6/16/2016 12:48:57 PM]

Commercially Mature Technologies for Treatment and Abatement of Chemical Vapors for Tanks - 05112016LKC - Federal Business Opportunities: Opportunities

Nitroso methyl-ethyl amine
Furans

The complete list of COPCs include the following classes of chemical compounds: alcohols, aldehydes, amines, aromatics, carbonyls, elemental mercury, furans, isocyanates, nitrates, nitrites, nitriles, nitro compounds, nitroso compounds, olefins, phosphates, phthalates, and pyridine. Responses to this request should discuss treatment of streams with COPC concentrations from the ppb range to higher concentrations (e.g., 1000 ppm) for the various compounds. For preliminary assessment, suppliers should consider removal to less than 10% of the prevailing Occupational Exposure Limits as a general performance guideline.

While the chemistry of the vapors is broadly distributed, this assessment will place emphasis and preference on technologies using simple, field-deployable technologies that treat the bulk of the odors.

TECHNOLOGY ASSESSMENT WORKSHOP DETAILS

Timing:

The Technology Assessment Workshop is tentatively scheduled for 19-21 July 2016 in the area of the Tri-Cities, Washington. The anticipated forum is to hold interview sessions involving single suppliers (i.e., separate session for each supplier). A limited number of sessions are practical; hence, SRNL and WRPS will evaluate technologies based on advance information submittals and parallel research and determine a selection of candidates for interviews during the workshop. The supplier will provide an overview of the proposed technology followed by question and answer session with a panel of SRNL and WRPS personnel. Requests for provision for participating via video or teleconferencing will be entertained although face-to-face briefings may prove more effective. In addition, SRNL and WRPS will entertain potential options for follow-up site visits and discussions should vendors offer (gratis) testing or demonstrations.

The Workshop discussions and information will be evaluated by SRNL and WRPS staff in the weeks following the exchange and continued interaction with viable technology providers and interested parties will be scheduled. The extent of the follow-up to the Workshop will be based on the information provided and SRNL / WRPS interest in the capabilities and technologies presented.

Additional considerations for attendees:

- Attendance at the Technology Workshop will be by invitation only. Invited responders will be notified by email/letter by 24 June.
- Travel, lodging and all other expenses incurred by the Workshop participants will not be reimbursed by SRNL, WRPS, or DOE.
- Post-Exchange interactions are at the sole discretion of SRNL and WRPS.
- There will be no Hanford Site access (i.e., site tours)

REQUEST

Interested parties are invited to submit an expression of interest to include a response to the following provisions.

1. By 11 July, 2016 (earlier submittals are encouraged) -- Provide a description of the technology

https://www.fbo.gov/...?s=opportunity&mode=form&id=2718640587513e8a8e1b3d6a16f07805&tab=core&tabmode=list&print_preview=1[6/16/2016 12:48:57 PM]

ATTACHMENT 1
List of Chemicals of Potential Concern

1,2,3-Propanetriol, 1,3-dinitrate	Acetaldehyde
1,3-Butadiene	Acetonitrile
1,4-Butanediol, dinitrate	Ammonia
1-Butanol	Benzene
2-(2-Methyl-6-oxoheptyl)furan	Biphenyl
2-(3-Oxo-3-phenylprop-1-enyl)furan	Butanal
2, 4-Dimethylpyridine	ButanenitrileButyl nitrate
2,3-Dihydrofuran	Butyl nitrite
2,4-Pentadienenitrile	Chlorinated Biphenyls
2,5-Dihydrofuran	Dibutylbutylphosphonate
2,5-Dimethylfuran	Diethyl Phthalate
2-Ethyl-5-methylfuran	EthylamineFormaldehyde
2-Ethyl-hex-2-enal	Furan
2-Fluoropropene	Heptanenitrile
2-Heptylfuran	Hexanenitrile
2-Hexanone	Mercury
2-Methyl-2-butenal	Methanol
2-Methylene butanenitrile	Methyl Isocyanate
2-Methylfuran	Methyl nitrite
2-Nitro-2-methylpropane	Nitrous Oxide
2-Octylfuran	N-Nitrosodiethylamine
2-Pentylfuran	N-Nitrosodimethylamine
2-Propylfuran	N-Nitrosomethylethylamine
3-(1,1-Dimethylethyl)-2,3-dihydrofuran	N-Nitrosomorpholine
3-Buten-2-one	Pentanenitrile
3-Methyl-3-butene-2-one	Propanenitrile
4-(1-Methylpropyl)-2,3-dihydrofuran	Pyridine
4-Methyl-2-hexanone	Tributylphosphate
6-Methyl-2-heptanone	

Appendix B. List of All Vendors Contacted

Company	Website	Point of Contact	Phone	Email	Participation
Calgon Carbon	www.calgoncarbon.com/remediation-air-treatment/	Rick Saunders	502.243.0604	rsaunders@calgoncarbon-us.com	Workshop
HEE/Duall	www.cecoenviro.com	Craig Thornton	989.627.9755	cthorton@cecoenviro.com	Workshop
Nestec	www.nestecinc.com	Jim Nester	610.323.7670x101	jnester@nestecinc.com	Workshop
W. L. Gore & Associates	www.gore.com/remedia	Chris Bryant	410.506.3238	cbryant@wlgore.com	Workshop
Schenck Process	www.schenckprocess.com/products/ModuPlasma	Dr. Jon Are Beukes		j.beukes@schenckprocess.com	Workshop
Alzeta	www.alzeta.com/exhaust-gas-abatement	Dave Bartz	800.676.8281x321	dbartz@alzeta.com	Workshop
John Zink Hamworthy	www.johnzink.com	Mark Campbell	918.859.8039	mark.campbell@johnzink.com	Workshop
Beltran Technologies	www.beltrantechnologies.com	Michael Beltran	718.338.3311	beltran@earthlink.net	Workshop
Nucon International	www.nucon-int.com	Joe Enneking	614.846.5710x111	joe.enneking@nucon-int.com	Workshop
Project Integration	www.pintegration.com	John Sudnick	864.334.5085	jjs@pintegration.com	Workshop
Comi Polaris Systems	www.comipolaris.com	Doug Bartus	336.693.5098	doug_bartus@comipolaris.com	Workshop
HGI Industries	www.hgiind.com	Jim Loggie	587.228.2002	jiml@hgiind.com	Workshop
Anguil Environmental	www.anguil.com	Jim Stone	630.818.5958 x1586	jim.stone@anguil.com	Workshop
Advanced Air Technologies	advairtech.com	Marv Biondi	800.295.6583x203	mbiondi@advairtech.com	Telecon
Bionomic Industries	www.bionomicind.com	David Meier	201.529.1094 x124	DMeier@bionomicind.com	Telecon
Babcock & Wilcox MEGTEC	www.megtec.com	Robert Vandenberg	920.337.1489	rvandenberg@megtec.com	Telecon
Strobic Air	www.strobicair.com	Chris Brassfield	859.595.3079	cbrassfield@cecoenviro.com	Telecon
Air Products	www.airproducts.com	Tori Reynolds	813.367.7224	info@airclear.net	Literature
Air Reps (Flanders)	www.airreps.com	Ken Porter	425.213.1152	kporter@airreps.com	Literature
Areva	www.areva.com	Dan Richey	509.371.1889	Daniel.richey@areva.com	Literature
CS Clean Systems	www.csclean.com	Peter Alibiso	603.867.8012	Peter.Alibiso@cscleansys.com	Literature

Company	Website	Point of Contact	Phone	Email	Participation
Linde - LoTox	www.lindeus.com/en/industries/pharma_and_biotech/biotech/vap_emission_control.html	Peter Studer	908.656.0301		Literature
Trelleborg	www.trelleborg.com/offshore	Bob Kelly	774.444.0424	bob.kelly@trelleborg.com	Literature
Upstate Electrical Technologies	www.uetcontrols.com	Ed Dustman Hal Cowles	877.253.5532 518.225.0315	ed@uetcontrols.com	Literature
Vapor Technologies	www.vapor-tech.net	Mark Varley	409.316.0173x218	Mark.varley@vapor-tech.net	Literature
Adwest Technologies	www.adwestusa.com	Brian Cannon	585.593.1405	bcannon@cecoenviro.com	None
Air Clear LLC	airclear.net	Rich Stone	443.245.3400	info@airclear.net	None
AMCEC Corp	www.amcec.com	Mike Tableriou	630.577.0400	sales@amcec.com	None
American Activated Carbon Corp.	www.aacarbon.com		310.491.2842	info@aacarbon.com	None
Applied Chemical Technology	www.appliedchemical.com/services/research_and_development/		256.760.9600	act@appliedchemical.com	None
Aquest Corp.	www.aquestcorp.com	Andy Roland	860.749.3938	info@aquestcorp.com	None
Aura Engineering	aura-engineering.com/engineering/vapor-cont/vapor-abatement-systems	Praveen Mogili	281.485.1105	Praveen.Mogili@Aura-Engineering.com	None
Calgon Carbon - UV	www.calgoncarbon.com	Casey Theys	724.218.7267		None
Camfil	www.camfil.us	Trent Thiel	510.325.9759	trent.thiel@camfil.com	None
Carbon Resources	www.oxbowactivatedcarbon.com	Zachary	561.907.5400		None
Carbtrol Corp	www.carbtrol.com	Ken Kikta	844.526.7192		None
Catalytic Products	www.cpilink.com	Barrett O'Donovan	847.438.0334	bodonovan@cpilink.com	None
CR Clean Air	www.crcleanair.com/products/wet-scrubbers/	Greg MacLeod	973.947.8787x121	gmacleod@crcleanair.com	None
Donau Carbon	www.donau-carbon.com				None
Durr Clean Technologies	www.durr-cleantechnology.com	Scott Brayton	248.450.2000	CTSsales@durrusa.com	None
Envirogen Technologies	www.envirogen.com/pages/technologies/air-treatment/	Ryan Sullivan	877.312.8950x1413	Info@envirogen.com	None
Environmental Tank and Container	www.etctank.com				None
Epcon Industrial Systems LP	www.epconlp.com	Shan Jamaluddin	936.273.3300	epcon@epconlp.com	None

Company	Website	Point of Contact	Phone	Email	Participation
Evergreen Industrial Services	www.evergreenes.com/services/vapor-control-and-degassing				None
Evoqua	www.evoqua.com/en/brands/IPS/Pages/vapor-phase-equipment-and-systems.aspx	Nick Capuzzi	936.273.3300		None
Falmouth Products	www.falmouthproducts.com/catalytic_oxidizer.html				None
Gulf Coast Environmental Systems	www.gcesystems.com	Keith Griffin			None
Indusco Industrial Services	www.induscoenviro.com/products/scrubbers/	Roger Fontaine	251.621.2338	rfontaine@induscoenviro.com	None
Monsanto Enviro-Chem, Inc	www.mecsglobal.com	Travis Arand	314.275.5700	northamerica@mecsglobal.com	None
Pavac Industries	www.pavac.com/technology-electronbeamfluegastreatmentebfgt		630.326.9012	info@pavac.com	
Perceptive Industries, Inc.	www.perceptiveindustries.com	Brad Hanna	269.204.6768	bhanna@perceptiveindustries.com	None
Purgit Vapor Control Systems	www.purgit.com	Townsend Hilliard	713.201.7517	Townsend@purgit.com	None
Schutte & Koerting	www.s-k.com	Bob Shirona	215.639.0900		None
Ship & Shore Environmental	www.shipandshore.com	Nina Zerman	562.997.0233	info@shipandshore.com	None
Terr-Aqua Enviro Systems	www.terr-aqua.net	Lynn Shugarman	626.806.7584 702.655.1212	lshugarman@terr-aqua.net	None
Zeeco, Inc.	www.zeeco.com	Rayan Tate	281.345.4110	sales@zeeco.com	None

Appendix C. Background Materials Provided to Vendors

This appendix contains background materials provided to the vendors beyond that included in the Request for Information. This information is informal to provide a basic description of the ventilation systems and the potential contaminants in the waste tank off-gas.

Active Ventilation Systems

Exhaust stack connected to 4 - 8 tanks.

Active systems, in general, contain a liquid layer

Exhaust Flow Rate at Stack: 1000 - 2000 scfm

Passive Ventilation Systems

Passive systems have had the liquid layer removed and only contain a salt cake.

VOC's still in the salt cake.

Exhaust Flow Rate up to 65 scfm per tank.

Boundary Concentrations reflect a potential bolus effect that must be abated.

It represents a value 3 orders of magnitude above the highest known headspace concentration.

Target Concentrations are the values to which emissions must be controlled during normal operation.

It represents 10% of the regulatory limit for the compound.

If emissions are controlled to less than the target concentration during normal operation then, it is assumed that the bolus condition will be controlled below the regulatory limit.

Spreadsheet is a work in progress and is being updated as sample data becomes available.

Temperatures for the active ventilation systems range from 57° F to 115° F. The temperature may drop lower but should not be significantly higher. For estimating purposes please assume the same temperature range for the passively ventilated systems. Please note if this temperature range is close to any limits for your technology.

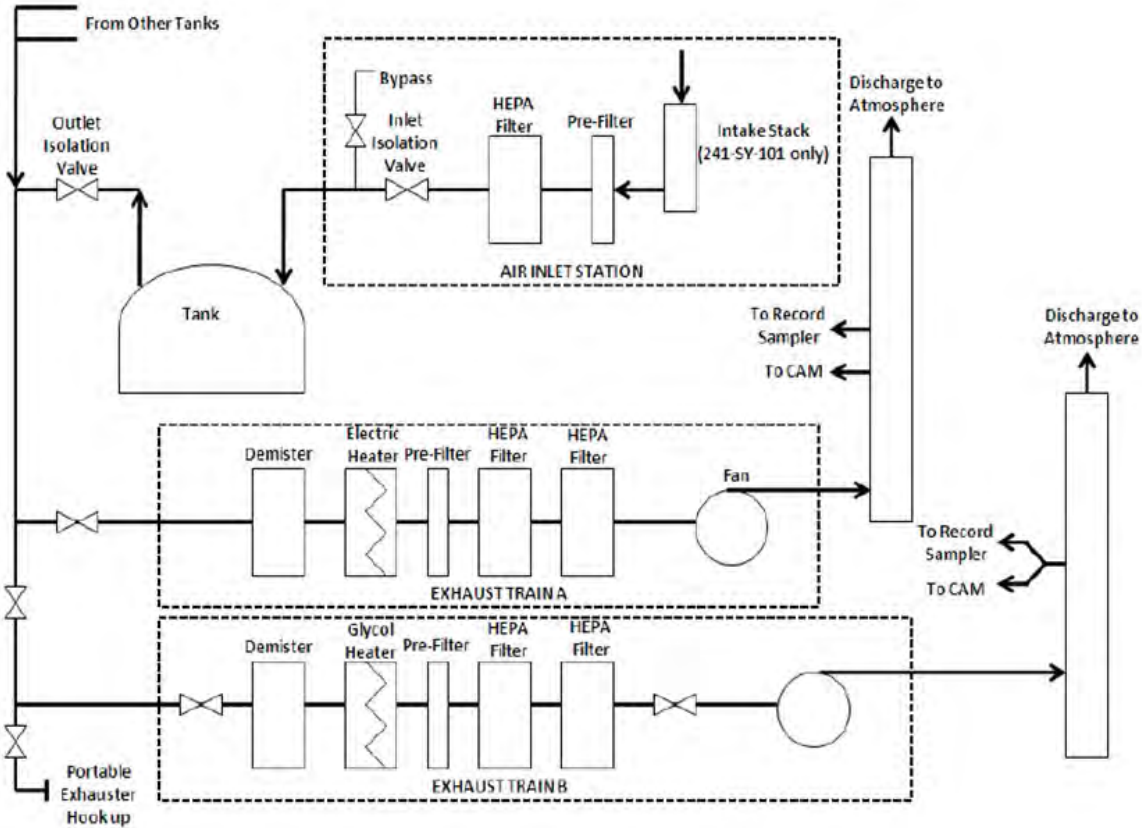

Figure C-1. Typical Active Ventilation System

Table C-1 contains a listing of chemicals of potential concern (Meacham, May 2006) as possibly present in the vapors emitted from the Hanford waste tanks. The numerical values for concentrations, targets, and required removal efficiency are not binding. Rather, the values provide an estimate of the potential range of concentrations. The targets and efficiencies do not represent final selected design values. The values are deliberately large to understand the influence of wide concentration ranges on the suggested technologies and scaling the equipment. The target values approximate 10% of the Occupational Exposure Limit in most cases.

Table C-1. Chemicals of Potential Concern

	Compound	Bounding Concentration	Maximum Concentration	Target	Required Efficiency (%)
Aldehydes	 formaldehyde	5.23e04 ppm	52.3 ppm	0.03 ppm	99.94
	 acetaldehyde	1.65e-01 ppm	1.65e-04 ppm	2.5 ppm	99.98
	 butanal	48.5 ppm	4.85e-02 ppm	2.5 ppm	99.48
	 2-methyl-2-butenal			3e-03 ppm	
	 2-ethyl-hex-2-enal			0.01 ppm	

Table C-1. Chemicals of Potential Concern

	Compound	Bounding Concentration	Maximum Concentration	Target	Required Efficiency (%)
Carbonyl	 2-hexanone	40 ppm	4.00e-02 ppm	12.8 ppm	
	 4-methyl-2-hexanone			0.05 ppm	
	 6-methyl-2-heptanone			0.8 ppm	
	 3-methyl-3-butene-2-one			2e-03 ppm	
	 3-buten-2-one	40 ppm	0.04 ppm	8.1 ppm	

Table C-1. Chemicals of Potential Concern

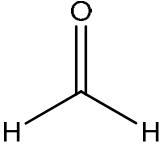
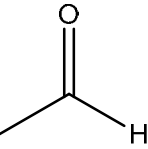
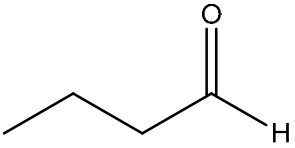
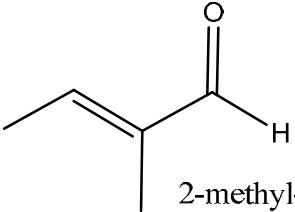
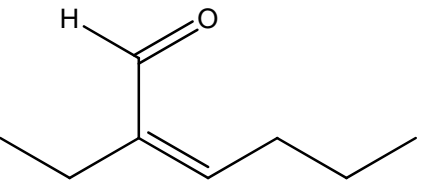

	Compound	Bounding Concentration	Maximum Concentration	Target	Required Efficiency (%)
Alcohol	 methanol	1.08e03 ppm	1.08 ppm	6.5 ppm	
	 1-butanol	110 ppm	0.11 ppm	11.8 ppm	
Furan	 furan	2.45e06 ppb	2.45e03 ppb	0.1 ppb	99.99
	 2-methylfuran	5e04 ppb	50 ppb	0.1 ppb	99.80
	 2,5-dimethylfuran	5e04 ppb	50 ppb	0.1 ppb	99.80

Table C-1. Chemicals of Potential Concern

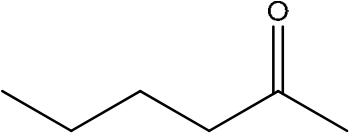
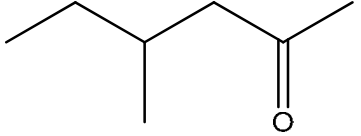
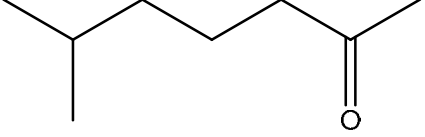
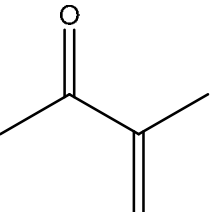
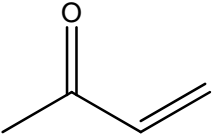
	Compound	Bounding Concentration	Maximum Concentration	Target	Required Efficiency (%)
	 2-ethyl-5-methylfuran	8.24e04 ppb	82.4 ppb	0.1 ppb	99.87
	 2-propylfuran	5.62e07 ppb	5.62e04 ppb	0.1 ppb	99.99
	 2-pentylfuran	1.05e03 ppb	1.05 ppb	6.5 ppb	
	 2-octylfuran	5e04 ppb	50 ppb	0.1 ppb	99.80
	 2-heptylfuran	4.76e04 ppb	47.6 ppb	0.1 ppb	99.78

Table C-1. Chemicals of Potential Concern

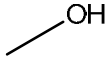
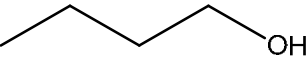
	Compound	Bounding Concentration	Maximum Concentration	Target	Required Efficiency (%)
	 2,5-dihydrofuran	4.6e06 ppb	4.6e03 ppb	0.1 ppb	99.99
	 2,3-dihydrofuran	5.62e07 ppb	5.62e04 ppb	0.1 ppb	99.99
	 3-(1,1-dimethylethyl)-2,3-dihydrofuran	5e04 ppb	50 ppb	0.1 ppb	99.80
	 4-(1-methylpropyl)-2,3-dihydrofuran	5e04 ppb	50 ppb	0.1 ppb	99.80
	 2-(2-methyl-6-oxoheptyl)furan	5e04 ppb	50 ppb	0.1 ppb	99.80

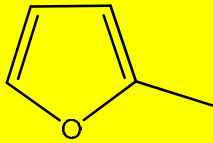
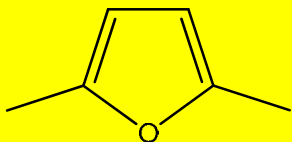
Table C-1. Chemicals of Potential Concern

	Compound	Bounding Concentration	Maximum Concentration	Target	Required Efficiency (%)
	 <p>2-(3-oxo-3-phenylprop-1-enyl)furan</p>	5e04 ppb	50 ppb	0.1 ppb	99.80
Aromatic	 <p>benzene</p>	888 ppm	0.888 ppm	0.05 ppm	94.36
	 <p>biphenyl</p>			0.02 ppm	
	 <p>chlorinated biphenyls</p>			0.1 mg/m ³	
Nitrate	 <p>1,2,3-propanetriol, 1,3-dinitrate</p>			5e-03 ppm	

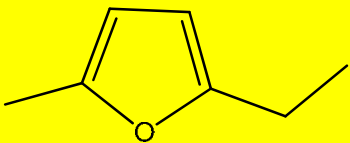
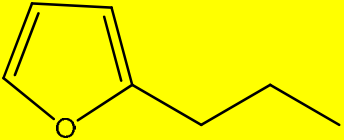
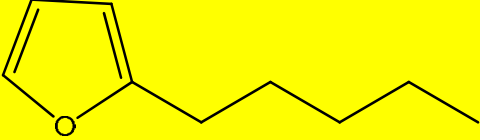
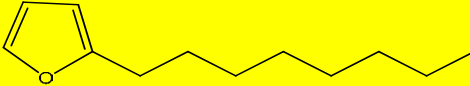
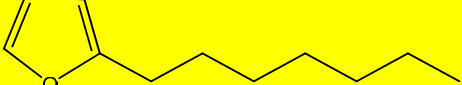
Table C-1. Chemicals of Potential Concern

	Compound	Bounding Concentration	Maximum Concentration	Target	Required Efficiency (%)
Nitrite	 1,4-butanediol, dinitrate			5e-03 ppm	
	 butyl nitrate			0.25 ppm	
	 methyl nitrite			0.01 ppm	
	 butyl nitrite			0.01 ppm	
Nitro	 2-nitro-2-methylpropane			0.03 ppm	

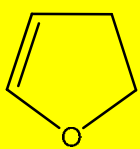
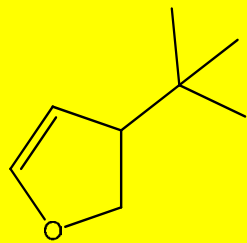
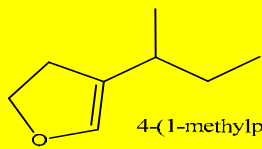
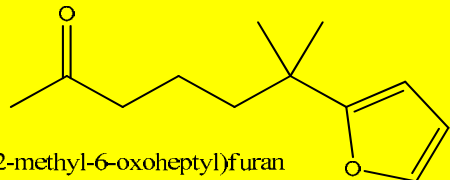
Table C-1. Chemicals of Potential Concern

Compound	Bounding Concentration	Maximum Concentration	Target	Required Efficiency (%)
 N-nitrosodimethylamine	1.9e04 ppb	19.02 ppb	0.03 ppb	99.84
 N-nitrosodiethylamine	3.28e05 ppb	328 ppb	0.01 ppb	99.99
 N-nitrosomethylethylamine	334 ppb	0.334 ppb	0.03 ppb	91.01
 N-nitrosomorpholine	30.9 ppb	0.0309 ppb	0.06 ppb	
 nitrous oxide	1.0e06 ppm	1000 ppm	5.0 ppm	99.50

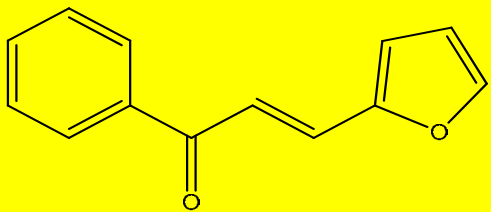
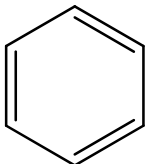
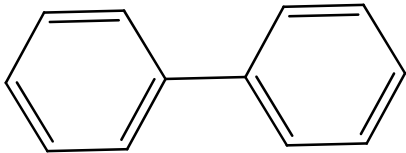
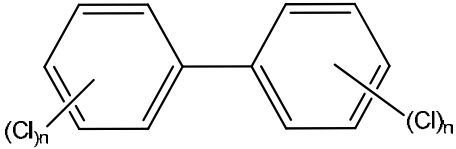
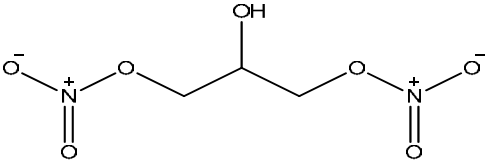
Table C-1. Chemicals of Potential Concern

	Compound	Bounding Concentration	Maximum Concentration	Target	Required Efficiency (%)
Amine	NH_3 ammonia	1.19e05 ppm	119 ppm	2.5 ppm	97.89
	 ethylamine	76.6 ppm	0.0766 ppm	0.5 ppm	
Pyridine	 pyridine	127 ppm	0.127 ppm	0.1 ppm	
	 2,4-dimethylpyridine	147 ppm	0.147 ppm	0.05 ppm	65.98
Phosphate	 dibutylbutylphosphonate			7e-04 ppm	

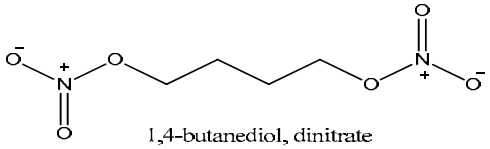
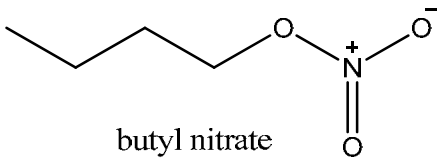
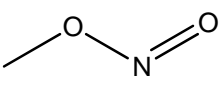
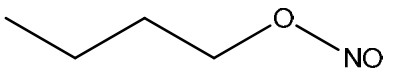
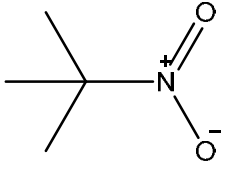
Table C-1. Chemicals of Potential Concern

	Compound	Bounding Concentration	Maximum Concentration	Target	Required Efficiency (%)
Phthalate	 tributylphosphate			0.02 ppm	
	 diethyl phthalate	627 mg/m ³	0.627 mg/m ³	0.5 mg/m ³	
Nitriles	 acetonitrile	4.44e03 ppm	4.44 ppm	2.0 ppm	
	 propanenitrile			0.6 ppm	
	 butanenitrile	3.3e05 ppm	330 ppm	0.8 ppm	99.75

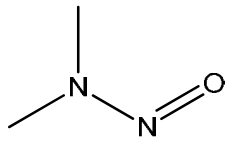
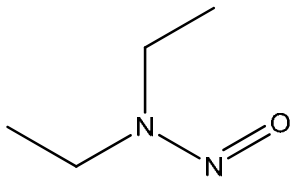
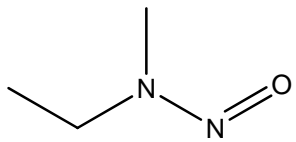
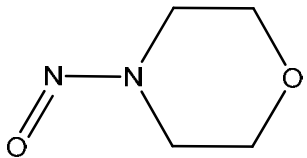
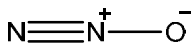
Table C-1. Chemicals of Potential Concern

Compound	Bounding Concentration	Maximum Concentration	Target	Required Efficiency (%)
 pentanenitrile	3.25e03 ppm	3.25 ppm	0.6 ppm	81.53
 hexanenitrile	51 ppm	0.051 ppm	0.6 ppm	
 heptanenitrile	99 ppm	0.099 ppm	0.6 ppm	
 2,4-pentadienenitrile			0.03 ppm	
 2-methylene butanenitrile	3.3e05 ppm	330 ppm	0.03 ppm	99.99

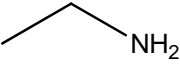
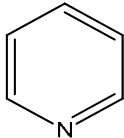
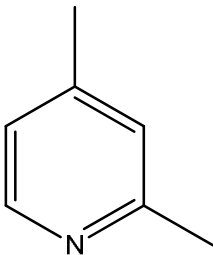
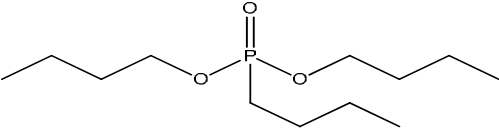
Table C-1. Chemicals of Potential Concern

	Compound	Bounding Concentration	Maximum Concentration	Target	Required Efficiency (%)
Isocyanate	 methyl isocyanate			2 ppm	
	 2-fluoropropene	47.7 ppm	0.0477 ppm	0.01 ppm	78.72
Olefin	 1,3-butadiene			0.1 ppm	
	Hg mercury	3.44e08 ug/m ³	3.44e05 ug/m ³	2.5 ug/m ³	99.99
Element					

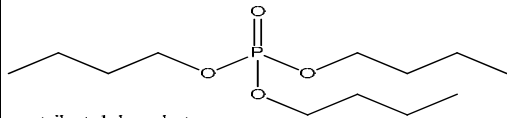
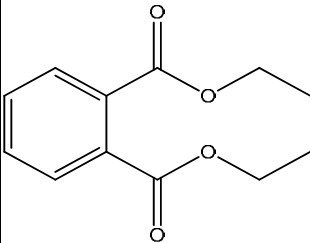
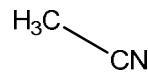
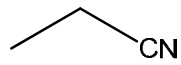
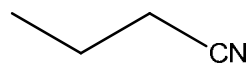
Appendix D. Evaluation Participants at the Workshop

Evaluation Team Participant	Organization	18 July	19 July	20 July	21 July
Dr. Samuel Fink	SRNL	x	x	x	x
Larry Romine	DOE-ORP Support	x	x	x	x
Troy Farris	WRPS	x	x	x	x
Jason Vitali	WRPS	x		x	x
Tim Moberg	WRPS	x	x	x	x
Mark Farrar	SRNL	x	x	x	x
Heather Burns	SRNL	x	x	x	x
George Weeks	WRPS	x	x	x	x
Tanya Williams	WRPS	x	x	x	x
Roby Enge	DOE-ORP		x	x	x
Elaine Diaz	DOE-ORP		x	x	x
Dr. David Hobbs	SRNL			x	x
Dr. Aaron Washington	SRNL		x	x	x
Billie Arthur	WRPS			x	x

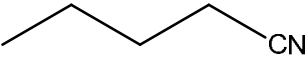
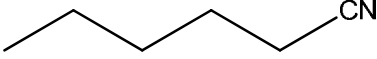
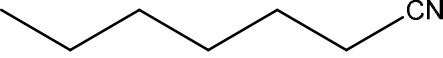
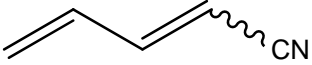
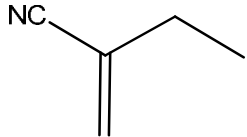
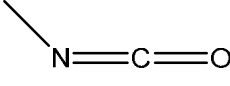
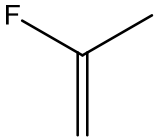
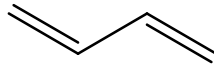
Key to Acronyms

DOE Department of Energy
ORP Office of River Protection
SRNL Savannah River National Laboratory
WRPS Washington River Protection Solutions

Appendix E. Overview of Upstate Electrical Proposal for Treatment

Upstate Electrical

Upstate Electrical is a control automation vendor specializing in monitoring and control systems for boiler systems, refrigeration systems, as well as VOC abatement systems. They teamed with Environmental C & C Inc. to propose a fluidized activated carbon bed for concentration and destruction of VOCs. The proposal uses a fluidized bed of beaded activated carbon to concentrate the VOCs. When the beads saturate they drop out of the fluidized bed and into a thermal desorber. The cleaned adsorbent returns to the bed with the concentrated stream of VOCs sent to a thermal oxidizer for final destruction. This approach can achieve concentration factors of 100 or greater reducing the size of the thermal oxidizer and, consequently, the fuel requirements for maintaining temperature in the oxidizer.

Upstate Electrical and Environmental C&C Inc. provided responses to the lines of inquiry but were not able to participate in the workshop or subsequent teleconferences due to previous commitments.

Technical Feasibility

The vendor claims removal of nearly all of the VOCs to a level of 1 ppm_v or less. Precise estimates of efficiency would require evaluation of sample data on a per tank basis. This proposal does not address mercury abatement. The carbon would capture perhaps as high as 70% of the mercury according to the vendor. However, treatment in the thermal oxidizer would release the mercury as either elemental mercury or oxides. The vendor does not expect the system to abate ammonia well. In addition, the proposal does not address NO_x. Therefore, the proposal would require secondary treatment of the fluidized bed exhaust and the thermal oxidizer exhaust using other technologies.

Design Features

The vendor has designed systems for flow rates of 200 scfm to 50,000 scfm. The vendor recommends designing the fluidized bed for the maximum flow rate with dilution air added to maintain minimum flow when necessary. The vendor recommends controlling the flow rate to within $\pm 20\%$ of design flow rate.

Inlet temperature should be ambient. The vendor prefers the temperature stays below 100°F, which requires inlet air conditioning. However, while Environmental C&C recommends an optimum temperature of less than 100°F, carbon vendors state a maximum temperature of 180°F, typically. The vendor recommends maintaining relative humidity of the inlet gas below 70% RH.

The desorber operates at a temperature of approximately 300° F, depending on the maximum boiling point of the constituents present. The vendor did not provide an operating temperature for the thermal oxidizer but, based on input from other vendors, that temperature should be less than 2000°F.

The treatment system will have an approximate footprint of 60 square feet and a height of 10 ft.

The system requires three phase power, natural gas or propane for the desorber and thermal oxidizer, and instrument air. The concentrator permits the use of a smaller thermal oxidizer operating on an exhaust stream with a high Btu rating; therefore, the vendor states the TO will operate at 20% of the fuel cost of a comparable regenerative oxidizer. This is a key attribute of this system.

Operational Considerations

The system consists of a fluidized bed concentrator, vapor desorber, and thermal oxidizer. The design would control each of these stages automatically using a PLC or similar device. Monitoring for alarms would occur either locally or remotely. For remote monitoring, the deployment should supplement with operator rounds to assess the physical plant, approximately once per shift or once per day.

The beaded activated carbon requires replacement approximately annually. The vendor recommends annual inspection of the burners and reaction chambers of the desorber and oxidizer as well as annual instrument calibrations.

Secondary Waste

The beaded activated carbon would require replacement annually.

The thermal oxidizer may create appreciable concentrations of NO_x, depending on composition of the inlet stream.

Safety/Regulatory

The safety considerations for deploying this proposal is similar for those of all thermal oxidizers (see Section 2.4.5).

It is uncertain whether the used bed will still contain sufficient contaminants (e.g., mercury) to rate as hazardous waste.

The treated off-gas from the oxidation process may contain undesirable byproducts such as nitrogen oxides (NO_x) or sulfur oxides (if the waste tank off-gas contains sulfur compounds).

Cost/Schedule

Upstate Electrical did not provide an estimate for this system but the costs will likely resemble those of a small thermal oxidizer. This system requires fabrication to specification. Therefore, fabrication of a system could likely occur within 6 months to 1 year of contract issuance.

Summary Rating

The Upstate Electrical/Environmental C&C proposal uses mature technology. However, the proposal does not address all of the chemicals of primary concern and requires additional stages of abatement. Table E-1 provides a summary of the evaluation of the Calgon Carbon’s proposed carbon adsorption system using the evaluation criteria and metrics in the Introduction.

Table E-1. Summary of Calgon Carbon’s Adsorption System Evaluation

Evaluation Criteria	Rating
<i>Technical Feasibility</i>	Yellow
<i>Design Features</i>	Green
<i>Operational Considerations</i>	Red
<i>Secondary Waste</i>	Green
<i>Safety/Regulatory</i>	Red
<i>Cost / Schedule</i>	Yellow

Distribution:

Connie C. Herman, SRNL
Jeannette E. Hyatt, SRNL
Heather H. Burns, SRNL
Mark E. Farrar, SRNL
Samuel D. Fink, SRNL
David T. Hobbs, SRNL
Aaron L. Washington, SRNL

George E. Weeks, AEM
Karthik Subramanian, WRPS
Jason Vitali, WRPS
Baide, WRPS
Troy Farris, WRPS
Tim Mosberg, WRPS
Tanya Williams, WRPS
Billie Arhur, WRPS

Elaine Diaz, ORP
Jim Lynch, ORP
Larry Romine
Dennis Irby, ORP